

# Mobile Home Guys, Inc.

## 2013 Catalog

22nd Edition



# Our Parts Fit!

3040 B St NW #16

Auburn, WA 98001

Office (253) 735-5155

Toll Free: 1-866-900-5155

Fax (253) 735-5909

Web Site [www.mobilehomesupply.com](http://www.mobilehomesupply.com)

# TABLE OF CONTENTS



S.S.I.

<b>Section 1000</b>	2-13	EXTERIOR, SET-UP, & AWNING PRODUCTS
<b>Section 2000</b>	14	WOOD PRODUCTS
<b>Section 3000</b>	15	FLOORING & SURPLUS PRODUCTS
<b>Section 4000</b>	15-17	PLUMBING FIXTURES
<b>Section 5000</b>	18-29	PLUMBING REPAIR PARTS & SUPPLIES
<b>Section 6000</b>	30-32	TAPES, CAULKS, HEAT REGISTERS & MISC. INTERIOR PRODUCTS
<b>Section 7000</b>	33	COATINGS, ROOFING PRODUCTS & VENTS
<b>Section 8000</b>	34-39	ELECTRICAL PARTS, FIXTURES & APPLIANCES
<b>Section 9000</b>	39-46	DOORS, WINDOWS & ACCESSORIES

**This catalog is designed to  
service the manufactured housing  
industry.**

01/2003

21st Edition

# Mobile Home Tie-down Systems

## Tie downs

100010 Cross Drive Anchor Only w/ 2-30" rods  
(8 per box)

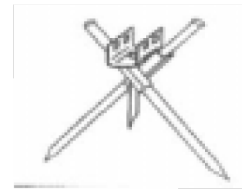

100013 Cross drive Head Only

100030 Concrete J-Hook (16 per bx)

100040 L.P. Tank Tie down kit  
(2-30" eye augers & 15' strap)



100050 Mollie-head & Bolt Anchors (50 per ctn.)

100051 Mollie-head only

100052 Mollie-bolt only

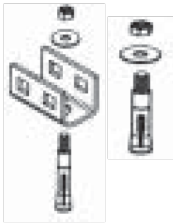

100072 36" Auger style (4 per pkg.)

100075 Auger Plate only

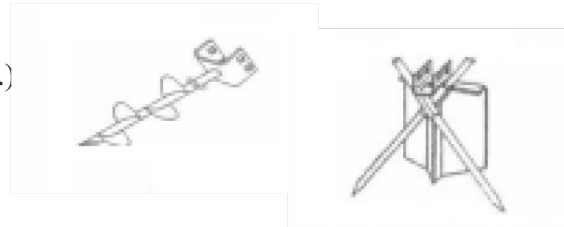

## Straps

100058 7' Strap w/ 5/8" hole (8 per bdl.)

100059 7' Strap w/hook (8 per bdl.)

100060 7' Strap w/buckle (8 per bdl.)

100061 15' Strap w/hook (4 per bdle)

100062 Strap Coil (675' coil)

100063 Strap Crimps

100064 Buckle ends

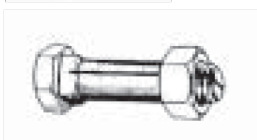

100070 Split Bolts (8 per bag)

## Blocks & Wedges



200010 2 x 8 x 16 Woods (10 per pkg.)

200029 Wedges-16" (50 per bdl.  
-450 Per pallet)



200030 Wedges-12" (30 per bdl.)

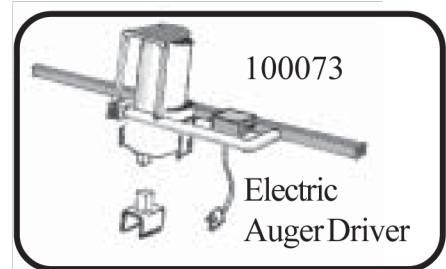
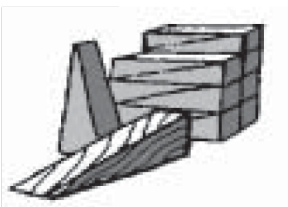
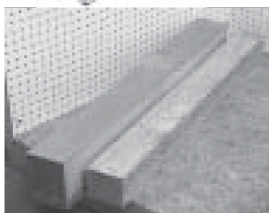

# Set-Up Products

## Magnum Foundation Systems

*-conforms to FHA standards for permanent foundation status!*

100501	size A	12" to 19"
100502	size B	16" to 23"
100503	size C	19 1/2" to 31"
100504	size D	24" to 38"
100505*	size E	31" to 52"
100506*	Cross-bracing for 100505	

Earthquake  
Resistant  
Bracing

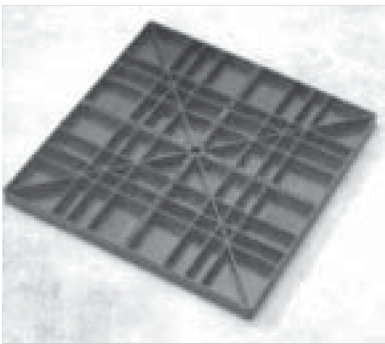
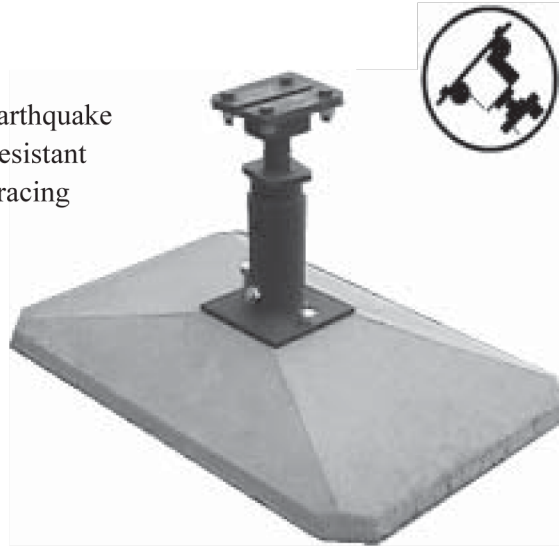

### Pier Pads

- Code-approved
- Light weight
- affordable

100507-16" x 16"  
A.B.S.Pier Pad

100535-20" x 20"  
A.B.S.Pier Pad

### Hex Head Screws

#### White Headed

100190  
#8 x 3/4-50ct.

#### Zinc plated

100179  
#8 x 1/2-50ct.

100178  
#8 x 3/4-100ct.

100184  
#8 x 3/4-500ct

100185  
#8 x 3/4-1000ct.

100182  
#8 x 1 1/4-50ct.

100183  
#8 x 1 1/4-100ct.

100189  
#8 x 1 1/4-500ct..

100186  
#8 x 1 1/4-50ct.

100187  
#8 x 1 1/4-100ct.

100188  
#8 x 1 1/4-500ct.

#### Self-Tapping Screws

110102-W  
#8 x 1/2 White-25ct.

110102-B  
#8 x 1/2 Brown-25ct.

110102-WL  
#6 x 3/4 White-25ct.

110102-BL  
#6 x 3/4-Brown-25ct.



200040  
Temporary Wooden Steps

# Skirting

# EVER LOCK Vinyl SKIRTING

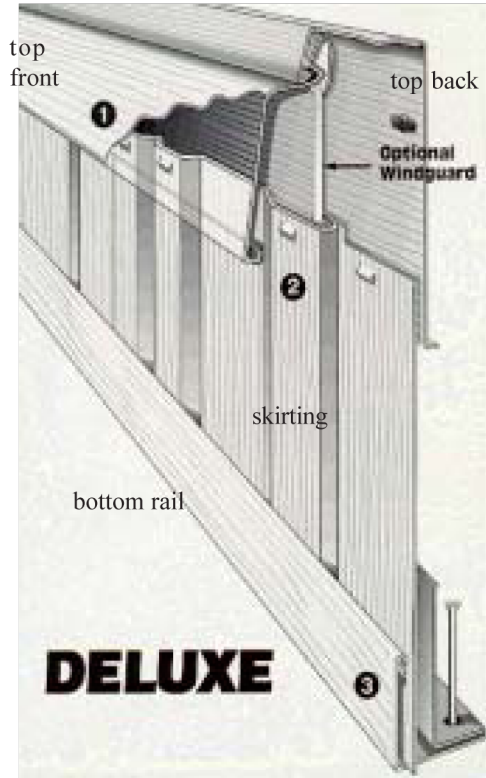

## Vinyl Skirting

-12 pc's per box

100222 Everlock All-Vent - Sand	16" x 12 ft.
100232 Everlock All-Vent - White	16" x 12 ft.
100242 Everlock All-Vent - Grey	16" x 12 ft.
100252 Everlock All Vent - Beige	16" x 12 ft.
100262 Everlock All-Vent - Tan	16" x 12 ft.

SIZE OF HOME	12 x 50	12 x 55	12 x 60	12 x 65	12 x 70	14 x 60	14 x 65	14 x 70	14 x 80	16 x 60	16 x 65	16 x 70	24 x 60	24 x 65	24 x 70	28 x 65	28 x 70
Perimeter	120'	130'	140'	150'	160'	144'	158'	162'	182'	148'	162'	166'	164'	174'	184'	165'	192'
16"-18"	12	13	14	15	15	14	15	16	18	14	16	16	16	17	18	18	18
19"-20"	13	14	15	17	18	16	17	18	20	16	18	18	18	19	20	20	21
21"-24"	15	17	18	19	20	18	20	21	23	19	21	21	21	22	23	23	24
25"-28"	18	20	21	23	24	22	24	25	28	23	25	25	25	27	28	28	29
29"-36"	23	25	27	29	30	27	30	31	35	28	31	32	31	33	35	35	36
37"-48"	30	33	35	38	40	36	40	41	46	37	41	42	41	44	46	46	48
Rail Kit to include: -Top back, Top front and Bottom rail	11	12	13	13	14	13	14	14	16	13	14	15	15	16	16	16	17

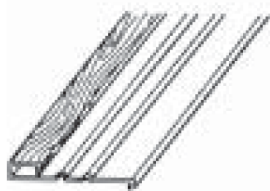

Top Back-12 ft.  
100261 Sand  
100271 White  
100281 Gray  
100291 Beige  
100301 Tan  
14 pc's per ctn.

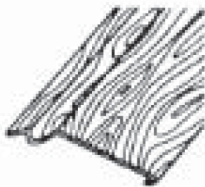

Top Front-12ft.  
100312 Sand  
100311 White  
100321 Gray  
100331 Beige  
100341 Tan  
14 pc's per ctn.



Bottom Rail - 12 ft.  
100352 Sand  
100351 White  
100361 Gray  
100371 Beige  
100381 Tan  
14 pc's per ctn.



Screw & Nail kit  
100390  
100qty- 7" nails  
100qty- 1" screws

# EVER ROCK SKIRTING

Grey, Brown, or Sand  
30", 36" or 48" tall

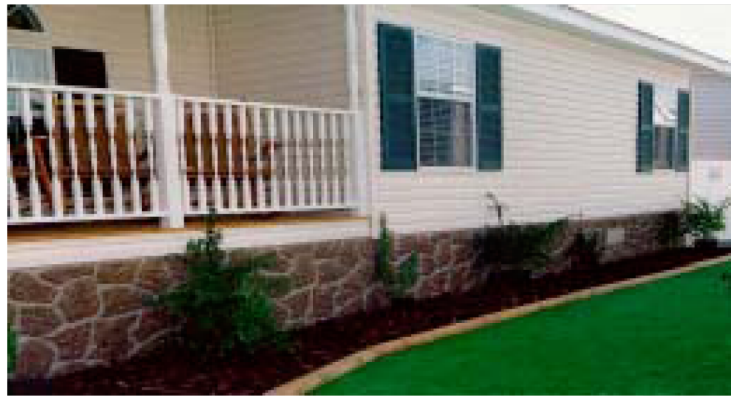

100392-specify height and length and color



## EverLock EZ Access Crawl Space Door

Frame size-26 1/4" x 34 5/8"  
Door Size -18" x 24"

100395-specify color

### Twin-Rib Aluminum Skirting\*

-available in  
25 sheet  
minimum  
orders  
-White  
-Grey  
-Brown  
-Cream

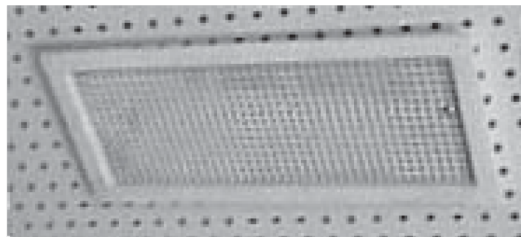

### Soffit/Skirting Vents

100121 White  
100131 Grey  
100141 Brown  
25 per box

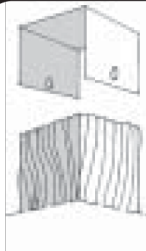

100160  
Ground Stake  
-250 bx  
100170  
Top clips  
-250bx



Handle  
100210



Turn clips  
100200

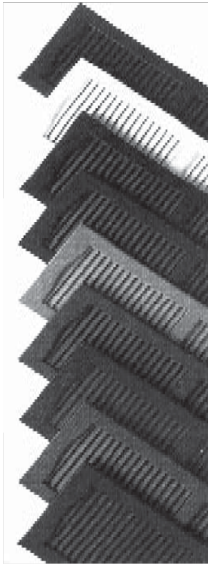

## Vinyl Shutters

*Lifetime Warranty!*  
*Paintable!*  
*More impact resistant*  
*than any other brand*

Available in Pairs  
 9,12, or 14" widths  
 18 to 144" tall

### COLORS AVAILABLE

Cream	Bedford Blue
White	Sienna Brown
Springmist Green	Black
Sage	Brandywine
Pewter	Colonial Blue
Pine Green	Dark Gray

149999-specify color

## Metal Roofing and Siding Products

8" Raised Woodgrain

ALUMINUM  
 SIDING

-White Only-

-8"x12'  
 -12 pcs per ctn.onl  
 100600

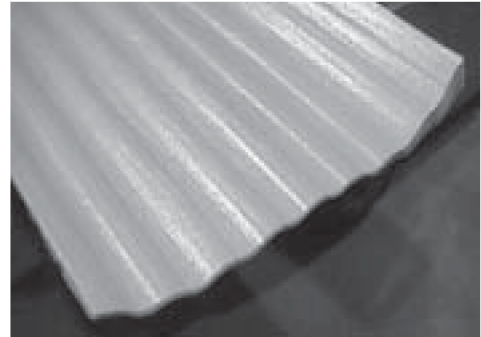
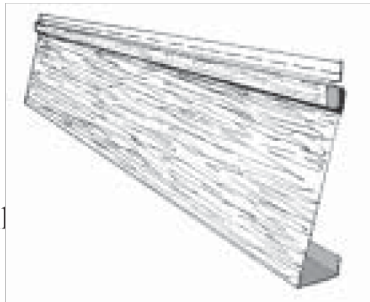

Mesa Aluminum Siding  
 -36" x 96" White only  
 -25pcs per ctn  
 163800

## WINDOW AWNING PARTS



### PANORAMA

**Custom Louvered  
 Window Awnings**

109800\*  
 -figure size  
 by square footage  
 (PRICING BASED ON 12  
 SQUARE FOOT MINIMUM)



**PANORAMA  
 PANEL**

110500\*  
 -per FOOT



**UNITIZING  
 BRACKET**

110505



**ADJUSTABLE  
 U-BRACKET**

110501



**COTTER  
 PINS**

110502



**OFFSET  
 SLEEVE**

110503



**3/4 WHITE  
 ALUMINUM TUBE**

110504\*



## Patio and Deck Awnings

108999\* Custom made to order.

*Call for a quote!*

### Universal Patio Cover Parts

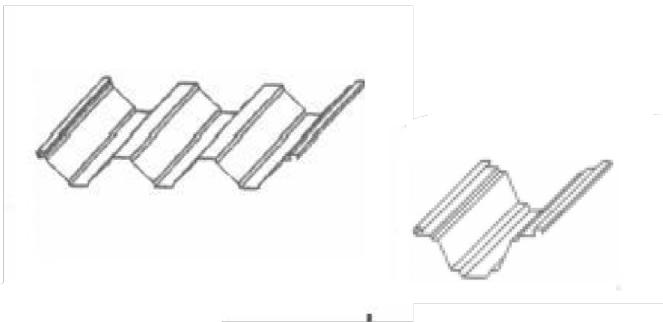

### AWNING PANS

- 110311\* 12" X .018 X FT.
- 110312\* 12" X .024 X FT
- 110313\* 12" X .032 X FT.
- 110314\* 12" X .036 X FT.
- 110325\* 3" X 24" X SQ.FT-.025
- 110332\* 3" X 24" X SQ.FT-.032
- 110340\* 3" X 24" X SQ.FT-.040
- 110425\* 4" X 12" X SQ.FT-.025
- 110432\* 4" X 12" X SQ.FT-.032
- 110440\* 4" X 12" X SQ.FT-.040

### GUTTER & SPLICES

- 110003\* Alaskan Gutter- 2 1/2"pans x ft.
- 110031 Alaskan Gutter Splice
- 110004\* Classic Gutter-3 1/2"pans x ft.
- 110041 Classic Gutter Splice (not shown)

### C-CHANNEL TOP RAIL

- 110013\* for 3" pans x ft.
- 110014\* for 4" pans x ft\* (not shown)

### V-CHANNEL TOP RAIL

- 110023\* for 3" pans x ft.
- 110024\* for 4" pans x ft.(not shown)

### FLASHING

- 110025\* 10" X 8 ft.

### CORNER PIECES

- 110033 for 3" pan
- 110034 for 4" pan (not shown)

### AWNINGRAIL

- 110100\* by the ft.

### PAN CLIP

- 110101

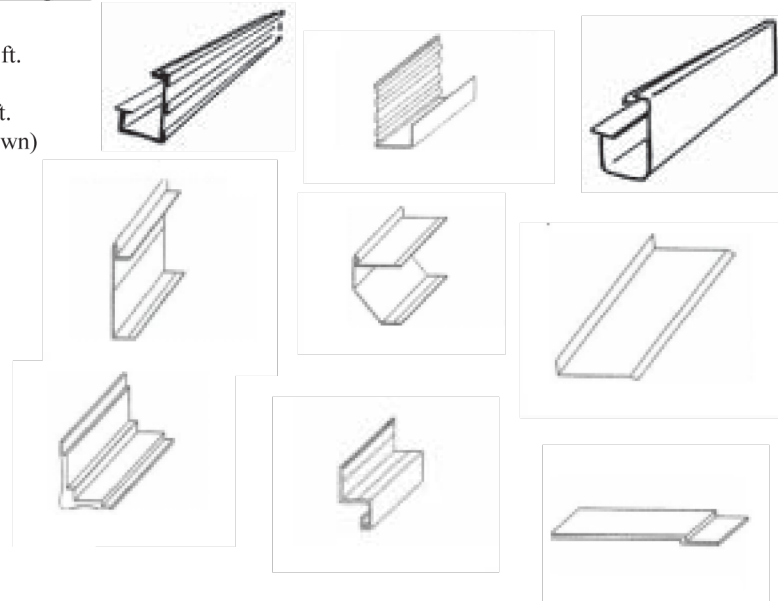



# The Finishing Touches for Outdoor Living

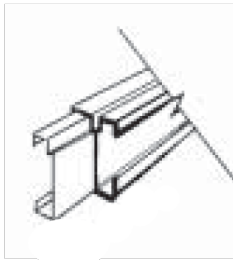

## I-BEAM & SPLICES

- 110054\* 4" I Beam x ft.
- 110055 4" I Beam Splice
- 110057\* 7" I Beam x ft.
- 110058 7" I Beam Splice

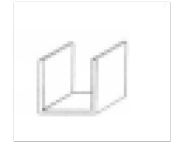
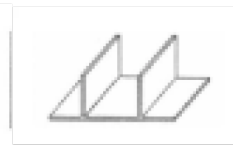

## POST BRACKETS

- 110103 3" Role post bracket
- 110104 3" Mag post bracket
- 110107 4" Post bracket



## ANCHOR BASE

110108



## SIDE FASCIA

- 110030\* 3" Side Fascia x ft.
- 110040\* 4" Side Fascia x ft

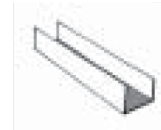

## COLUMN SHOES & BRACKETS

- 110105 1 1/2" Wh. Column Shoe



## POSTS

- 110117\* 8' x 1 1/2" x .062 white post
- 110118\* 10' x 1 1/2" x .062 white post
- 110119\* 12' x 1 1/2" x .062 white post
- 110120\* 20' x 1 1/2" x .062 white post
- 110121\* 24' x 1 1/2" x .062 white post

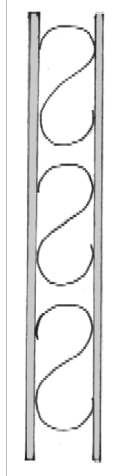

## SCROLL POST

- 110124 8' x .062 Scroll Post-white\*
- 110126 10' x .062 Scroll Post-white\*
- 110128 12' x .062 Scroll Post-white\*



## 3" ROLL-FORM CLOVERLEAF POST

- 110140\* 8' white
- 110142 10' white
- 110144\* 12' white\*



## 3" EXTRUDED POST

- 110146\* 8' white
- 110148 10' white
- 110150\* 12' white

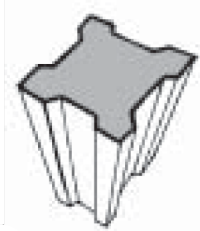

## 3" STEEL POST

- 110153\* 10' x 3" white
- 110154\* 12' x 3" white



## AWNING SKYLIGHT PARTS

- 110200\* 6" Clear Acryllac x ft.

## DOWNPOUT PARTS

- 100442 2" x 3" Drain out
- 100443 2" x 3" White downspout
- 100437 2" x 3" White elbow
- 100444\* 2" x 3" Wh. downspout kit w/elbow



## PAN DAMS

- 100438 Small Dam for gutter
- 100439 Lg. Dam for pan

# CONQUEST<sup>®</sup>

## QUALITY VINYL SIDING



150101 Double Dutch Lap  
 Double 4 1/2" exposure  
 12' 1" panel length  
 1/2" field butt height  
 Subtle cedar grain texture  
 Low-gloss finish.  
 040" nom. thickness



150121 Double Traditional  
 Double 4 1/2" exposure  
 12' 1" panel length  
 1/2" field butt height  
 Subtle cedar grain texture  
 Low-gloss finish  
 0.040" nom. thickness

- Glacier White
- Antique Parchment
- Natural Linen
- Platinum Gray
- Silver Moss
- Coastal Sage
- Cape Cod Gray
- Mystic Blue
- Adobe Cream
- Colonial Ivory

2 squares per carton  
 22 panels per carton

**150101 Double Dutch Lap**  
**150121 Double Traditional Lap**

**Specify Color**

### Vinyl Siding Accessories

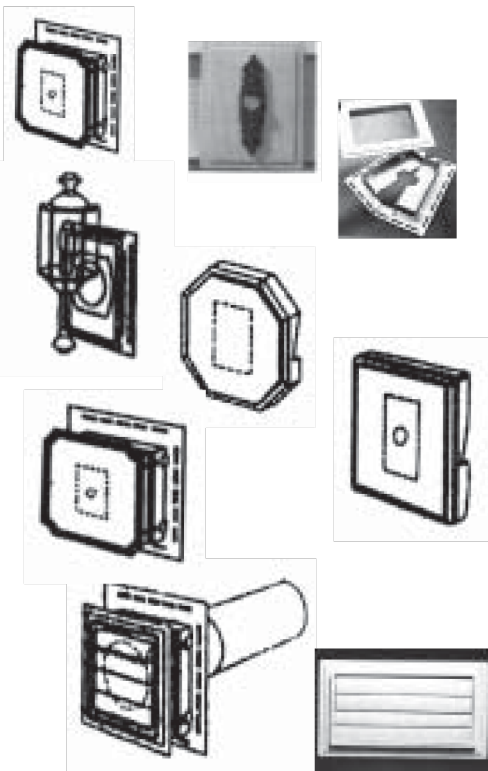

- |        |  |                 |
|--------|--|-----------------|
| 157020 | 2-pc Two Piece J-Block-Spec. Color-5 per box   | 7 x 7           |
| 157025 | Mini J-Block-Spec. Color-5 per box             |                 |
| 157026 | Mini Recessed J-Block- Spec. Color - 5 per box |                 |
| 157027 | J-Block / Coachlite-5 per box                  | 7 x 11          |
|        | Specify Color                                  |                 |
| 157080 | Octagon Block-double lap-5 per box             | 6 3/4" x 6 3/4" |
|        | Specify Color                                  |                 |
| 157110 | Octagon Block-Dutch lap-5 per box              |                 |
|        | Specify Color                                  |                 |
| 157090 | Octagon Block-T-3 lap-5 per box                |                 |
|        | Specify Color                                  |                 |
| 157089 | Octagon Block-Trim it-5 per box                |                 |
|        | Specify Color                                  |                 |
| 157040 | EZ Block-double lap-5 per box                  | 6 3/4" x 6 3/4" |
|        | Specify Color                                  |                 |
| 157070 | EZ Block-Dutch Lap-5 per box                   |                 |
|        | Specify Color                                  |                 |
| 157050 | EZ Block-T-3-5 per box                         |                 |
|        | Specify Color                                  |                 |
| 157049 | EZ Block-Trim it-5 per box                     |                 |
| 157130 | 2-piece J Vent-1 per box                       | 7" x 7"         |
| 157150 | Range/Foundation Vent-5 per box                | 4" x 8"         |

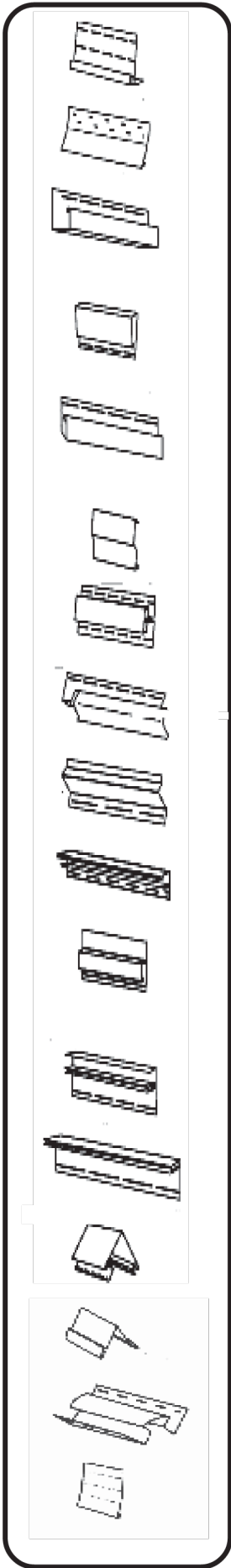

## Siding Trim

### Starter Strip

- 150302 Vinyl Starter Strip-10' lgth./50per ctn.-500ft./ctn.
- 150303 Sturdy Starter Strip-10' lgth./50per ctn-500ft/ctn
- 150581 Metal Starter Strip

### J-Channels

- 150305 1/2"-Specify Color-12'6"lgth./40 per ctn-500ft/ctn
- 150306 5/8"-Specify Color-12'6"lgth./40 per ctn-500ft/ctn
- 150318 5/8"-Cdr.Ln-Spec. Color-12'6"lgth/40 per ctn-500ft/ctn
- 150307 3/4"-Specify Color-12'6"lgth./40 per ctn-500ft/ctn
- 150319 3/4"-Cdr.Ln-Spec. Color-12'6"lgth/40 per ctn-500ft/ctn
- 150308 1 1/8"-Spec. Color-12'6"lgth./40 per ctn-500ft/ctn
- 150316 J Channel-Wide Flange-12'6"lgth./40per ctn-500ft/ctn  
White only
- 150321 Undersill Trim-12'6"lgth./40per ctn-500ft/ctn  
Specify color
- 150323 Undersill Trim Cdr.Ln-12'6"lgth/40 per ctn/500ft ctn  
Specify color
- 150329 Wide Crown Molding-12'6"lgth./24per ctn.-300ft./ctn  
Almond, Blue, Cream, Gray, & White only

### H-Channel

- 150343 H-Molding-12'6"lgth./24per ctn.-300ft./ctn.  
Specify color
- 150344 Narrow Cove Molding-12'6"lgth./24per ctn.-300ft/ctn.  
Specify color
- 150331 1 3/8" Drip Cap-12'6"lgth./24per ctn.-300ft/ctn  
White only
- 150342 1/2"F-Trim-12'6"lgth./40per ctn.-500ft/ctn  
Specify color

### Window-Door Trim

- 150346\* Window/Door Trim-8'lgth/40per ctn-320ft/ctn  
White only
- 150347\* Window/Door Trim-12'6"lgth./40per ctn.500ft/ctn.  
Almond, Blue, Clay, Cream, Gray & White only
- 150348\* Freeze Back Plate-12'6"lgth/40per ctn-500ft/ctn.  
White only
- 150349\* Universal Back Plate-12'6"lgth/40per ctn-500ft/ctn

### Outside Corner Post

- 150371 3" x 3/4" x 10' lgth-Specify Color-/ 12 per ctn/120ft/ctn
- 150372\* 3" x 1 1/8" x 10' lgth-Specify Color/ 12 per ctn/120ft/ctn.
- 150373\* 3" x 3/4" x 8'6" lgth-Specify Color/ 12 per ctn/120ft/ctn
- 150354\* Snap-On Outside Corner Post-10'lgth-24per ctn-120ft/ctn  
Specify Color
- 150361 3/4" Inside Corner Post-10'lgth-10per ctn-100ft/ctn  
Specify Color

### Inside Corner Post

- 50363 3/4" Inside Corner-Cdr. Ln-10ft. lgth-10 per ctn-100ft/ctn  
Specify Color

### Fascia

- 150383 8" Fascia-12'6"lgth-24per ctn.-300ft./ctn.  
Specify Color



## LUAN AND GYPSUM PANELING

221000	OAK-Luan	48" x 96"
222000	ADOBE-5/16"Gypsum	48" x 90"
222005	ADOBE-Luan	48" x 96"
222003	DRYWALL-5/16"Gypsum	48" x 90"
222004*	DRYWALL-5-16"Gypsum	48" x 115"

*Now available in PALLET quantities!*  
 -100 pcs. per pallet pricing for Luan products  
 -50 pcs. per pallet pricing for Gypsum products

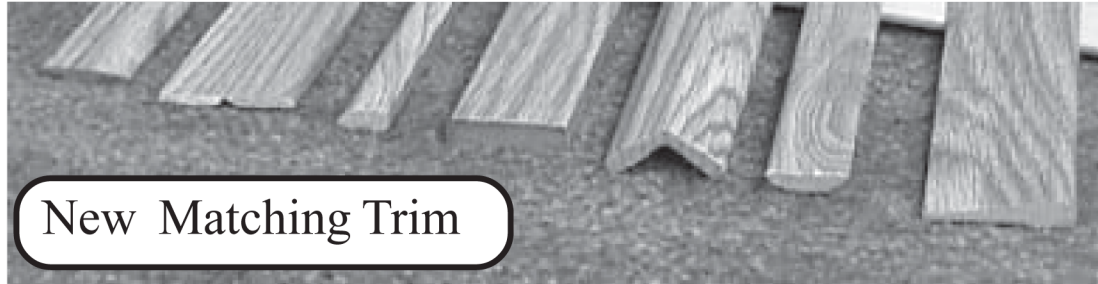
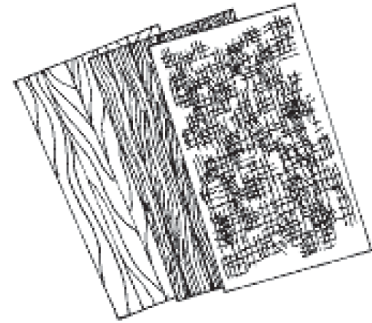

### New Matching Trim

#### Batten Strips

211010	96" Oak batts-15/16"
211011	96" Oak batts-11/16"
211015	96" Oak-Hinged batts 1 3/8"
212010	96" White batts-15/16"
222010	96" Adobe batts
222011	115" Adobe batts
222015	120" Adobe -Hinged batts
224010	90" Millenium Multi
224015	90" M.M.-Hinged batts

#### 1/4 Round

211020	84" Oak
212080	84" White

#### Door Stop 3/8" x 1 3/16"

211030	84" oak
212030	84" White

#### Outside Corner - 1"

211050	96" Oak
212050	96" White



#### 3/4" Inside Corner

211040	84" Oak -
212040	84" White

#### 1 3/8" Trim Casing

211060	96" Oak
212060	96" White

#### Panel Nails

100180	1 5/8 x 150 Oak
100181	1 5/8 x 150 White

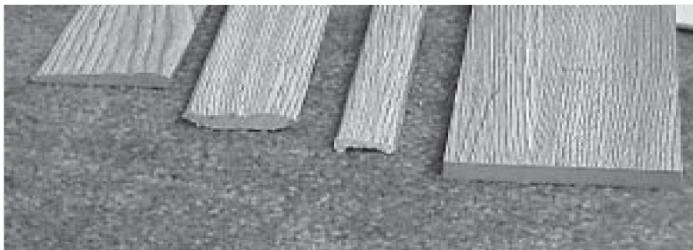

#### 2 1/4 Trim Casing

211070	96" Oak
212070	96" White

#### 1 1/2" Crown Molding

211080	96" Oak
212080	96" White

#### 1" Lip Molding

211090	96" Oak
212090	96" White

#### 3 3/8" x 3/8 Jamb

211110	84" Oak
212110	84" White

#### Plastic Tub Molding

212100	84" White
213100	84" Almond

#### 1 5/8" Header Board

212121	96" White
--------	-----------

#### 4" Header Board

212120	96" White
--------	-----------

# United Paneling Cabinets

## Base Cabinets

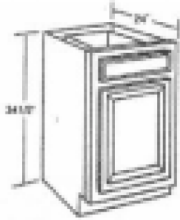

- 23B09L 9 x 34
- 23B12L 12 x 34
- 23B15L 15 x 34
- 23B18L 18 x 34
- 23B21L 21 x 34

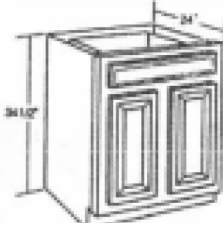

- 23B24IL 24 x 34
- 23B27L 27 x 34
- 23B30L 30 x 34
- 23B36L 36 x 34
- 23B42L 42 x 34

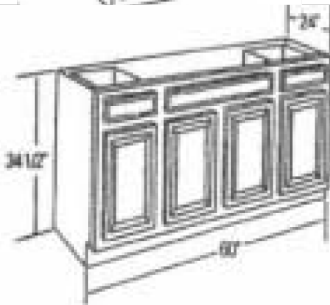

- 23WSB30L 30 x 34
- 23WSB26L 36 x 34
- 23WSB42L 42 x 34
- 23WSB60L 60 x 34

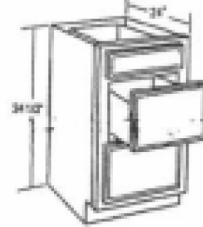
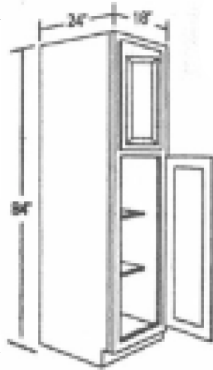

23BBC36L 36 x 34 Blind

- 23DB15L 15 x 34
- 23DB18L 18 x 34
- 23DB21L 21 x 34
- 23DB30L 30 x 34

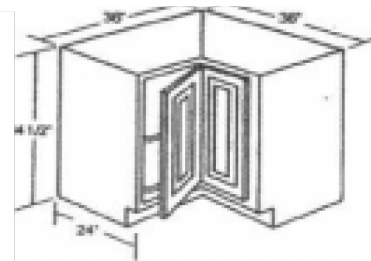

23DCB3612L 36 x 34

- 23WP1884L 18 x 84
- 23WP2484 24 x 84

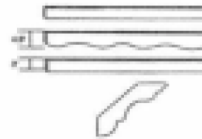

- 23FS30L wall filler
- 23TK8L Toe kick
- 23VAS 48L 4' Scalloped valence

## OverHead Cabinets

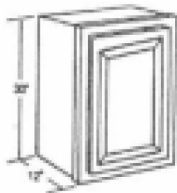

- 23W0930L 9 x 30
- 23W1230L 12 x 30
- 23W1530L 15 x 30
- 23W1830L 18 x 30
- 23W2130L 21 x 30

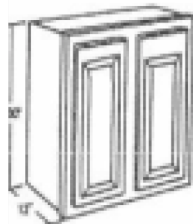

- 23W2415L 24 x 15
- 23W2730L 27 x 15
- 23W3015L 30 x 15
- 23W3018L 30 x 18
- 23W3030L 30 x 30
- 23W331524 33 x 15 x 24d
- 23W361524 36 x 15 x 24d
- 23W3615H 36 x 15H
- 23W3630H 36 x 30H
- 23W4230H 42 x 30H

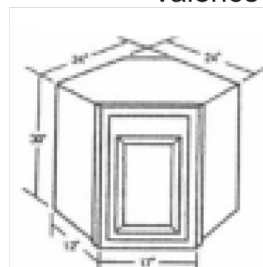

23WDC2430L 24 x 30

*"All of these Cabinets are 100 % Oak and plywood construction. There is no particle board "*

## Bathroom Cabinets

*"All of these Cabinets are 100 % Oak and plywood construction.  
There is no particle board "*

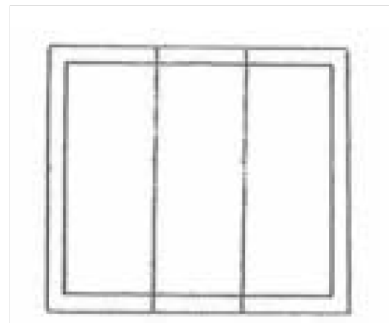

23TRV4830 48 x 30 mirror

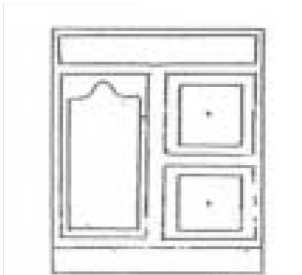

23VA3021DL 30 x 21

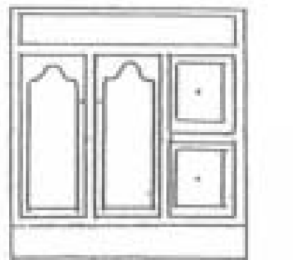

23VA3621DL 36 x 21

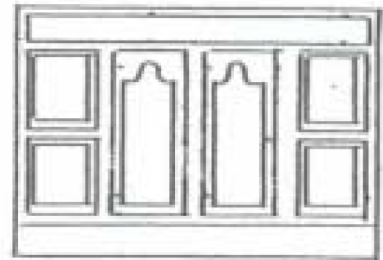

23VA4821DL 48 x 21



300020\* 14'vinyl flooring  
specify style-call

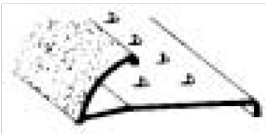

300052 Carpetr bar 12ft



300051  
Carpet tack strip

## Flooring Products

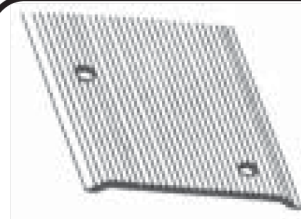

**Aluminum  
Marriage  
Seam**

300054 2 1/2 x 12  
300055 4 x 12

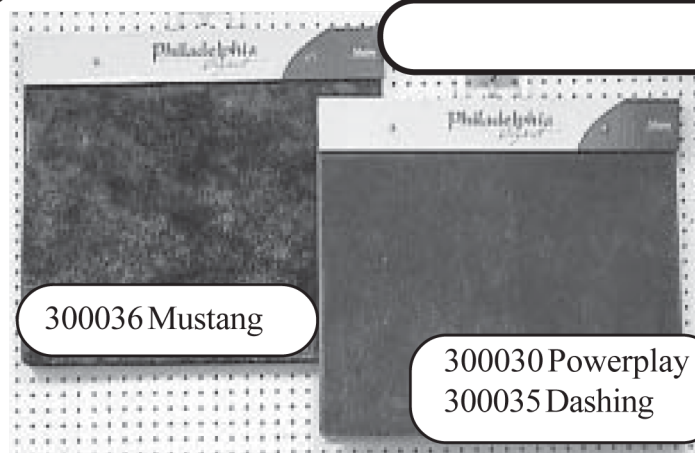

300036 Mustang

300030 Powerplay  
300035 Dashing

# Tubs & Accessories



**Now  
Improved !  
New Heavy Duty  
Construction.  
These tubs  
are now Factory  
Guaranteed  
for 3 full years!**

These Other Designer Tubs Available  
on

Special Order Basis Only  
**#408888**

- 3660 36" x 60" x 17 3/4"  
Island-Rectangle-L.H./R.H.
- 4200 42" x 60" x 21 1/8"  
Island-Oval-L.H./R.H.
- 4260 42" x 60" x 17 3/4"  
Island-Rectangle-L.H./R.H.
- 4264 42" x 64" x 19 3/8"  
Island-Oval-C.D.
- 5400 54" x 54" x 22 1/2"  
Corner-no apron -C.D.
- 5400a 54" x 54" x 22 1/2"  
Corner-w/apron-C.D.

*All Designer Tubs available  
with Jacuzzi option*

## NEW!

### *Permalux Bath Tub Option*

Polymer-Alloy High Gloss/High Impact  
Acrylic Finish Tub Products.

*Special Order Features:*

- Replaces Fiberglass
- Durability and Stain-Resistance
- No Chipping, Peeling or Spiderwebs
- U/V Protection
- 5 year Warranty

*Option offered on most models.*

## Standard Mobilehome Bathtubs

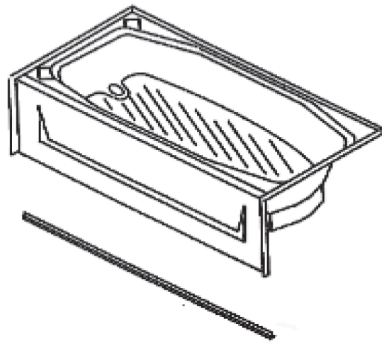

- 400010 27" x 54" White  
with left hand drain
- 400020 27" x 54" Almond  
with left hand drain
- 400030 27" x 54" White  
with right hand drain
- 400040 27" x 54" Almond  
with right hand drain

## 30" x 60"

### Standard Bathtubs

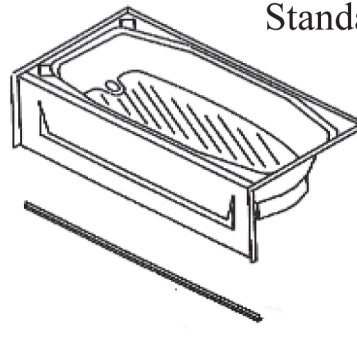

- 400090 White  
Left Hand
- 400100 Almond  
Left-Hand
- 400110 White  
Right-Hand
- 400120 Almond  
Right-Hand

## 42" x 60" Tub with Center Drain



- 400055 White\*
- 400065 Almond\*

Garden Tubs.  
Shower Pans,  
&  
Wall Surrounds

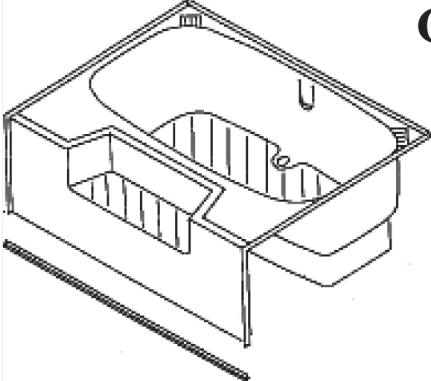

**Garden Tubs**  
**40" x 54"**  
400050  
White  
w/skirt  
400060  
Almond  
w/skirt

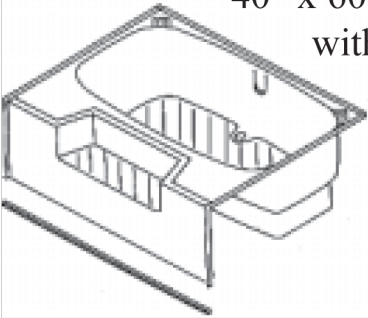

40" x 60" Garden Tub  
with center drain  
400130 White  
400140 Almond

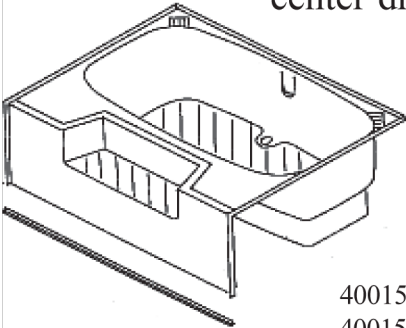

48" x 60" Garden Tub with  
center drain  
400152 White  
400153 Almond

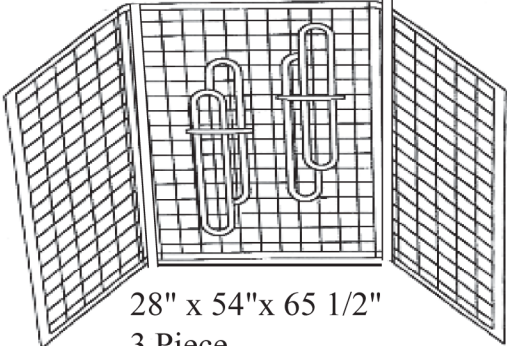

28" x 54" x 65 1/2"  
3 Piece  
Shower  
Surround  
400163 White  
400164-Almond



32"  
Shower Pan  
400166 White  
400167 Almond



**ALSO NEW!**  
500023 1 1/2" Drain w/grid  
Shower Drain



28" x 54"  
Shower Pan  
400154 L.H. White  
400155 L.H. Almond  
400156 R.H. White  
400157 R.H. Almond



Surrounds, Glass Doors and Installation Supplies

Tile-Style Surround

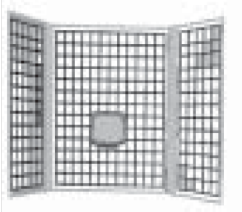

- 400170 27" x 54" White
- 400171 40" x 54" White
- 400172 40" x 54" Almond
- 400176 27" x 54" Almond
- 400185 27" x 54" White-3 pc.
- 400186 27" x 54" Almond-3 pc.
- 400187 42" x 54" White-3 pc.
- 400188 42" x 54" Almond-3 pc.
- 400201 40" x 60" White
- 400202 40" x 60" Almond

Picture Frame Surround

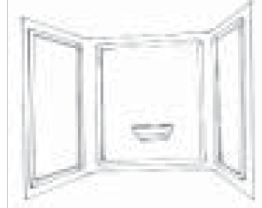

- 400173 27" x 54" Almond
- 400174 27" x 54" White
- 400181 40" x 54" Almond
- 400182 40" x 54" White
- 400191 30" x 60" Almond
- 400192 30" x 60" White
- 400203 40" x 60" Almond
- 400204 40" x 60" White

Shower By-Pass Door

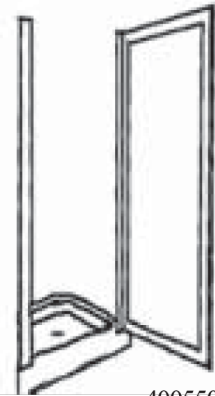

Shower  
Stall  
Door

400550 32"  
Shower Door

Surround Installation  
Adhesives



Shower Stall  
Surround

32" x 32"

- 400168 White
- 400169 Almond

Tub Surround  
Flange Locks



400208  
-7 per tub



Spray Adhesive  
600180 -12 pr ctn

Max-Bond  
600324 -24 pr ctn

Nylon Moly-Rivets  
for Shower  
Surround



- 400215 Wht. (25)
- 400216 Alm. (25)



- 400211 Almond
- 400212 White

Corner Braces  
for Surround  
Installation



400500  
up to 54" x 55"  
Tub/Shower Door-  
obs.  
- fits our 54 tubs

400510 up to 56" x  
66"  
Shower Door-obs.  
-fits our 2854 shower

Corner Caddy for 3-Piece  
Surround

- 400213  
-White
- 400214  
-Almond

These corner caddies may  
be used with any three-piece  
54" surround to accomodate  
all 60" tubs.



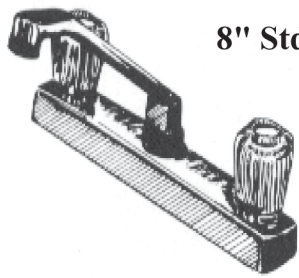

**8" Std. Kitchen Faucet**

400269-8"  
400270-8"

**Chrome Single Lever Faucet  
w/int. brass body**

400273  
8" Kitchen Faucet

400274  
Kitchen Faucet w/spray

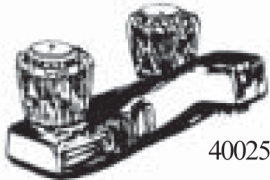
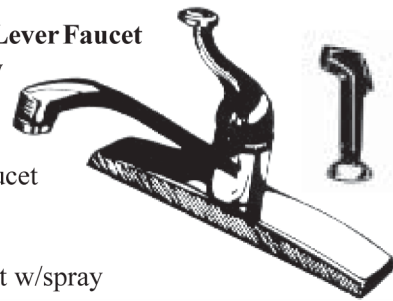

**Lavy Faucet**

400250 Standard 4"  
Celcon body-Chrome



**4" Single Knob  
Lavy Faucet**

400251- Sgl, knob lav. faucet  
500385-repairkit



400220  
8" Chrome Shower & Bath Faucet  
400220W  
8" White Shower & Bath Faucet



400225  
8" Shower & Bath

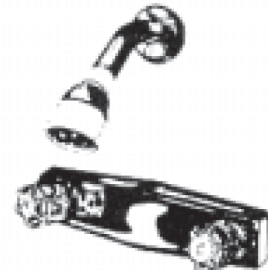

400232  
8" Exposed Shower  
Valve  
-Plastic



**8" Three-Valve  
Diverter**

400230  
Phoenix Diverter  
complete with  
head & spout



**Single knob  
Shower & Tub  
Diverter**



400255  
-Sgl. knob dvtr. comp  
500538-Rep.knob  
500385 Rep.kit



**Garden Tub  
Filler**

400240 Garden Tub Filler  
500569 Rep. knobs.set

**8" Two-Valve  
Diverter**

400231  
Phoenix Diverter  
complete with  
head & spout



**Deck Mount  
Diverter**



400241  
Deck Mount Diverter

**Replacement Spouts & Adapters**



500602  
Metal Spout  
with 1/2ft in nose



500603  
Metal Spout w/diverter  
with 1/2 ft in nose



PHOENIX  
Shower  
Arm  
& Flange 500597



**Empire**  
500552 Small-pr.  
500553 Large-pr.  
500563 Large-ctr.  
500547 Button Set

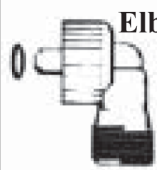

**Utopia  
Faucet  
Elbow**  
500322



400321 Shower  
Head Only



PHOENIX  
Replacement  
Shower Head  
kit  
500564



**Single Lever  
Shower Knob**  
500538



500566  
Garden Tub Spout



500565 Diverter Tee

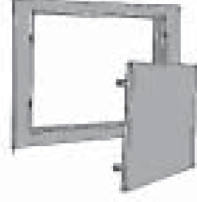

600101  
14 x 14  
Access  
Panel



500392



**Pipe  
Faucet  
Fittings**  
500560  
1/2" x 5"  
Nipple  
  
500561  
1/2" Elbow



**Phoenix**  
500551 Small pr.  
500558 Small ctr.  
500569 Large pr.  
500575 Lever-style  
500605 Button Set-Sm.  
500606 Button Set-Lg.



**Faucet Knobs**  
  
**Utopia**  
500555 Utopia Clear-pr.  
500568 Utopia Smoke-pr  
500544 Utopia Button-Hot  
500545 Utopia Button-Cold



**Diverter  
Knob**  
  
500556 Utopia  
500558 Phoenix



**Valve Seats**  
  
500549 Empire  
-1" plastic  
500543 Phoenix  
1" brass

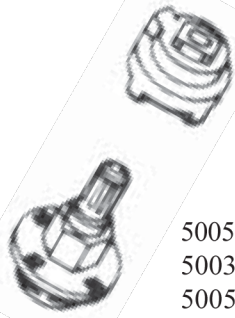

**Plastic  
Faucet  
Stems  
& Locks**

- 500562-Utopia Valve Stem
- 500395-Utopia Stem Lock
- 500567-Utopia  
Diverter Repair Kit
- 500386-Phoenix Valve Stem
- 500387-Phoenix Stem Lock



**Phoenix Diverter Stems**



500389 Old Style



500391 New style

**Phoenix or Streamway  
Faucet Stems**

- 500393  
Garden Tub  
Fixtures
- 500388  
Lav/Kit  
Fixtures



**Empire Faucet  
Stem**

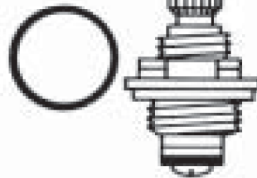

- 500394 Tub Stem kit-pr
- 500548 O-ring kit
- 500396 Lav Stem kit-pr



**EMPIRE  
Diverter  
Stem  
500554 Empire**

**Sink Baskets and Drain Stoppers**



**3 1/2" Plastic Basket  
& Strainer  
w/Stainless Steel Ring**

500010 Complete



**3 1/2" All-Steel  
Chrome Plated  
Basket & Strainer**

500012 Complete  
500013 Basket only

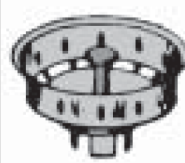

**3 1/4"  
Stainless Steel  
Strainer Only**

500011 Crumb basket

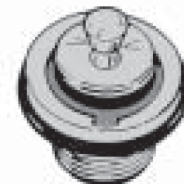

**2 1/2" Bath Tub  
& Lav Sink Drain**

500020 Chrome Plastic

**Shower  
Drains**



500022  
3 1/2" Std.

*Made Special  
To fit Our 27 x 54  
Showar stall*



500023  
2 1/2" to fit our  
28" x 54" stall



**1 1/4" x 5"  
Lavatory  
Drain**

500032

**1 1/4"  
Drain Plug**

500034  
Plug fits 500032



**TIP TOE**

**Tub  
Stopper**



**500040**  
2 1/2" Tub Stopper  
w/5/16" stud (complete)

# Kitchen and Bathroom Sinks

**Stainless Steel Double Sink  
4 Hole-Self rimming**

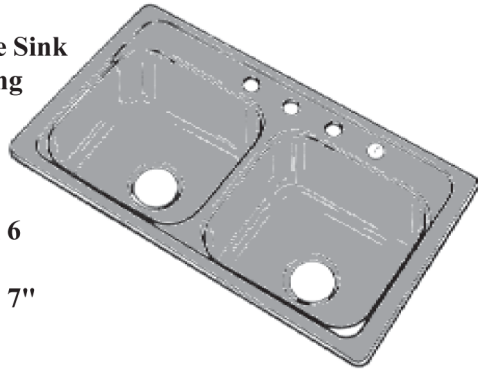

33" x 19" x 6  
400330 S.S.  
33" x 19" x 7"  
400328 S.S.

**19 x 33 x 7" Deep  
Fiberglass Self- Rimming Sink**



Featuring off set sized 7" deep basins and 8" center set faucets.  
400327-White  
400347-Almond

**Stainless Steel Double Sink  
w/o Holes-Self rimming**



33" x 17" x 6"  
400331  
32 1/8" x 16" cut out  
w/3 1/2" drains

400371  
self-rimming  
Porcelain  
Kitchen & Lav



400372  
S.S-dbl. li



400372b  
S.S. dbl. lip



400373  
S.S. Sgl.lip

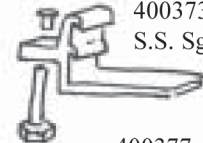

400374  
Porc. Lavy

400374b  
Plastic Lavy

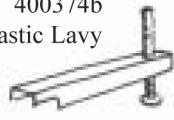

400377  
19 x 33  
Fiberglass



400375  
Plas. Lavy

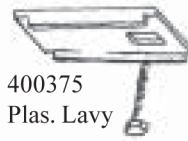

## Sink Clip Sets

**17" x 20"  
Porcelain Lav Sink**

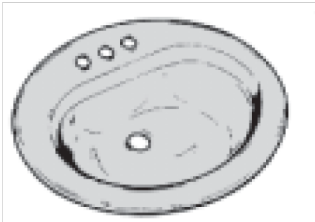

400361 Almond  
400362 White

The PERFECT Replacement for the Poly Lavs.

**17" x 20"  
Plastic Lavy Sink**



400381 White  
400391 Almond

This is the "other" Lavy sink., it has noticeably squared off rear corners.

**17" x 20"  
Poly Lav Sink**

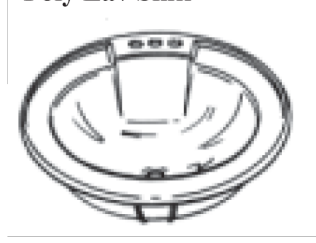

400380 White  
400390 Almond

This is the "ORIGINAL". Featuring an A.B.S.-Acryllac finish, and an oval cut-out.

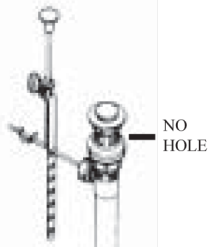

500031

**Pop-up Drain  
w/o overflow**



500030

**Pop-up  
Drain  
w/Overflow**

**Dishwasher  
Drain-Air  
Gap**



500530

**Trap  
Vent**



500520  
Vent  
and  
Adapter

## Toilet Parts



**Standard  
Over-flow  
and  
Flapper**

500092

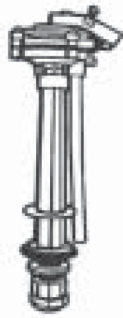

**Standard  
Anti-syphon  
Plastic  
Ballcock**

500090



**Fluidmaster  
Flush  
Valve Kit**

500100



**TOILET  
FLAPPER**

500095

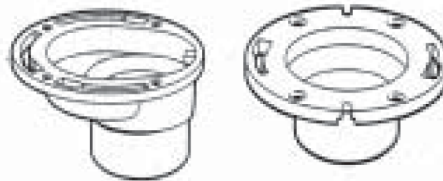

**Toilet Flanges**

500051 3" Female Slip  
500052 3" Male Slip  
500053 3" Fem Slip  
w/offset  
500056 3" M.P.T.  
500057 3" F.P.T.

## A.B.S. SET UP FITTINGS

- 530104 3" female-slip Coupler
- 530304 3" C.O. adapter-hub x F.P.T.
- 530324 3" C.O. adapter-spig x F.P.T.
- 530604 3" 45d Elbow
- 530704 3" 90d Elbow
- 530714 3" 90d L.T. Elbow
- 530715 3" 45d L.T. Wye
- 530734 3" 90d Street elbow
- 530804 3" 22d elbow
- 531104 3" San. Tee
- 531204 3" 90d L.T. Wye

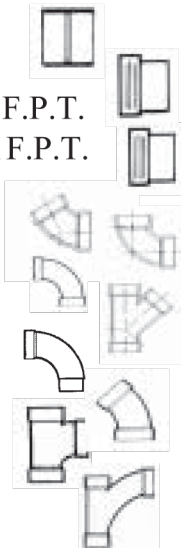

**A.B.S. Pipe**

500800 1 1/2" x 10  
500801 3" X 10



*Carton  
Quantities  
are  
available!*



**ABS  
Glue-Pint  
500084**

**PLUMBING VENTS**



500510 Metal  
500515 Plastic

**A.B.S. Swivel Trap Adapter**



500035  
1 1/2 fem. hub x 1 1/2 fpt swivel  
500038  
1 1/2 male spig. x 1 1/2 fpt swivel

**A.B.S. P-trap**



**500044-1 1/2" P-Trap w/ union**  
**500047- 1 1/4" P-Trap**

**TRAP ADAPTERS & WASHERS**

**500036**  
1 1/2" Rubber Flat Washers



**500048**  
1 1/2" Bevel Washer

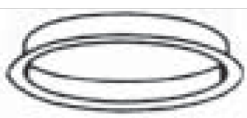
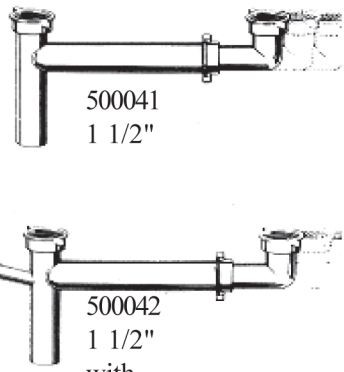

**500054**  
1 1/2" Nylon Lip Washer

**500041**  
1 1/2"

**500042**  
1 1/2" with dishwasher drain fig.

**A.B.S. slip C.O. TRAP ADAPTER w/nut**



500058  
1 1/2 spig x 1 1/4 mpt  
500062  
1 1/2 spig x 1 1/2 mpt  
500063      1 1/2 hub x 1 1/2 mpt



**A.B.S. PIPE COUPLER**



500037 1 1/2"  
530104 3"

**Flex-PEX TUBING**

**CROSS-LINKED POLYETHELENE TUBING**

- ENGEL method manufactured
- Heat repairable
- Rated to 180 F.degrees at 80# P.S.I.
- Available either by the 20ft piece or in 100 ft. coils.

**-25 Year warranty by certified installer**

- 570002C or H    3/8" I.D. x 20ft
- 570003C or H    1/2" I.D. x 20ft
- 570004C or H    3/4" I.D. x 20ft
- 570102C or H    3/8" x 100ft
- 570103C or H    1/2" x 100ft
- 570104C or H    3/4" x 100ft
- 570105C\*        1" x 300ft



ONE TOOL FOR ALL SIZES, RATCHET PINNERS WILL NOT RELEASE UNTIL CLAMP IS PROPERLY CLOSED



**500165**



**3/4" Gate Valve**



500083

**FROST FREE SILL COCK**



500540 6"  
500539 8"

**UPONOR tubing cutter**



500162



**Water Heater 18" PIGTAIL**

500570  
3/4 FPT X  
3/4 FPT

# PEX WATER SYSTEMS



## PEX RINGS

### UPONOR

- 571002 - 3/8" I.D.
- 571003 - 1/2" I.D.
- 571004 - 3/4" I.D.
- 571005 - 1" ID

### Steel

- 500704\* - 3/8" I.D.
- 500705\* - 1/2" I.D.
- 500706\* - 3/4" I.D.
- 500707\* - 1" ID.

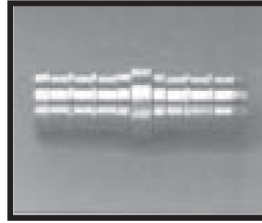

## PEX COUPLING

- 574022 3/8PEX - 3/8PEX
- 574033 1/2PEX - 1/2PEX
- 574043 3/4PEX - 1/2PEX
- 574044 3/4PEX - 3/4PEX
- 574045 3/4PEX - 1 PEX
- 579033 1/2 PEX- 1/2 POLY
- 579044 3/4PEX - 3/4 POLY

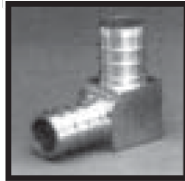

## PEX ELBOW

- 575022 3/8PEX - 3/8PEX
- 575033 1/2PEX - 1/2PEX
- 575043 3/4PEX - 1/2PEX
- 575044 3/4PEX - 3/4PEX
- 575055 1"PEX - 1"PEX



## PEX ADAPTER

- 573023 3/8PEX - 1/2 MPT
- 573033 1/2PEX - 1/2 MPT
- 573034 1/2PEX - 3/4 MPT
- 573043 3/4PEX - 1/2 MPT
- 573044 3/4PEX - 3/4 MPT
- 573055 1"PEX - 1"MPT



## PEX MALE ELBOW

- 575122 3/8PEX - 3/8MPT
- 575123 3/8PEX-1/2MPT
- 575132 1/2PEX -3/8MPT
- 575133 1/2PEX - 1/2 MPT
- 575134 1/2PEX - 3/4MPT
- 575144 3/4PEX - 3/4MPT



## PEX TEE

- 576333 1/2PEX - 1/2PEX - 1/2PEX
- 576334 1/2PEX - 1/2PEX - 3/4PEX
- 576433 3/4PEX - 1/2PEX - 1/2PEX
- 576434 3/4PEX - 1/2PEX - 3/4PEX
- 576443 3/4PEX - 3/4PEX - 1/2PEX
- 576444 3/4PEX- 3/4PEX- 3/4PEX
- 576544 1"PEX - 3/4PEX - 3/4PEX
- 576554 1"PEX - 1"PEX - 3/4PEX
- 576555 1"PEX - 1"PEX - 1"PEX

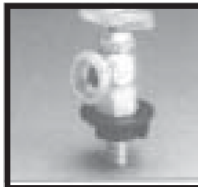

## PEX WASHING MACHINE VALVE

- 578333 1/2PEX - 3/4 MGH

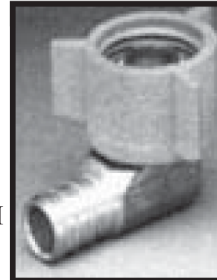

## TEST PLUG

- 577002 3/8 PLUG
- 577003 1/2 PLUG
- 577004 3/4 PLUG
- 577005 1" PLUG



## PEX ICE-MAKER VALVE

- 578033
- 1/2PEX - 1/4 COMP

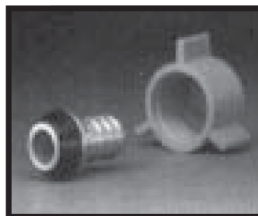

## PEX SWIVEL ELBOW

- 575233 1/2PEX - 1/2FPT
- 575244 3/4PEX - 3/4FPT

## PEX SWIVEL COUPLER

- 572023 3/8PEX - 1/2FPT
- 572033 1/2PEX - 1/2FPT
- 572034 1/2PEX - 3/4FPT
- 572044 3/4PEX- 3/4FPT
- 572152 Ballcock - 3/8PEX
- 572153 Ballcock - 1/2PEX

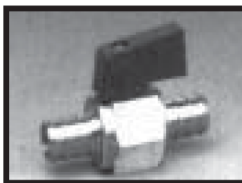

## PEX IN-LINE VALVES

### GATE VALVE

- 578133 1/2PEX - 1/2MPT

### BALL VALVE

- 578222 3/8PEX - 3/8PEX
- 578233 1/2PEX - 1/2PEX



## BEND SUPPORT

- 583035 FOR 3/8 TUBING
- 583033 FOR 1/2 TUBING
- 583051 FOR 3/4 TUBING



## PEX IN-LINE BALL VALVE

- 578444
- 3/4PEX - 3/4PEX BALL VALVE



## PLASTIC U-NAILS

- 583085 FOR 1/2" TUBING
- 583086 FOR 3/4" TUBING
- 583087 FOR 1" TUBING



# Flair-It

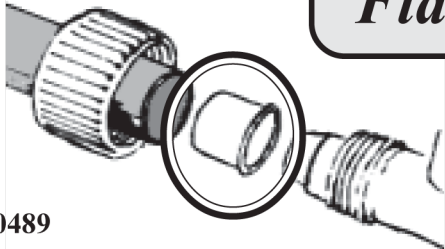

**500489**  
3/4" POLYBUTELENE ADAPTER



**Flair-It Wrench**

500481 3/8 x 1/2-02390  
500482 1/2 x 3/4-02391

**Washing Machine Valve**

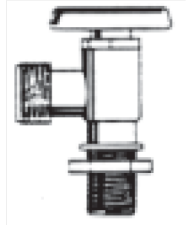

500425 1/2mpt-06886

**Flair-It Ice Maker Valve**



500423 Needle Valve  
500424 1/2p x 1/2p x 1/8fpt

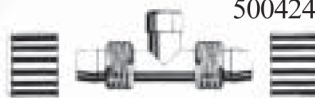

**Flair-It Nut**



500502 3/8-06840  
500503 1/2-06418  
500504 3/4-06454

**Flair-it Bevel Washer**



500380 1/2-06435  
500390 3/4-06465

**Flair-it Cap**

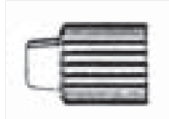

500506 1/2-06860  
500507 3/8-06868  
500508 3/4-06861

**Flair-it Plug**

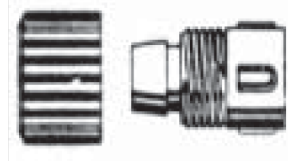

500505 1/2-06863  
500509 3/4-06864

**Notice!**

3/8" and 1/2" Flair-It fittings are compatible with both Polybutelene and P.E.X. cross-linked polyethelene tubing.

**Drop Eared Elbow**

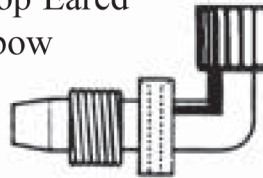

500402-1/2p x 1/2fpt-06801

**Ballcock Adapter**

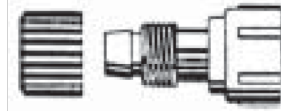

500408 3/8p x 5/8 fpt-06869  
500409 1/2p x 5/8 fpt-06865

**Stop Valve**



500410 3/8p x 3/8p-06879  
500420 1/2p x 1/2p-06880

**Drain Valve**

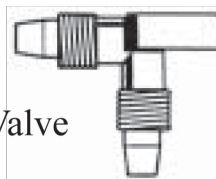

500411 1/2p x 1/2p-06884

**Angle Stop Valve**

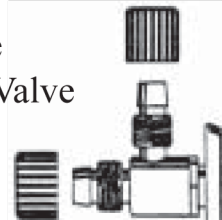

500412 1/2p x 1/2p-06885  
500413 3/8p x 3/8p-06883

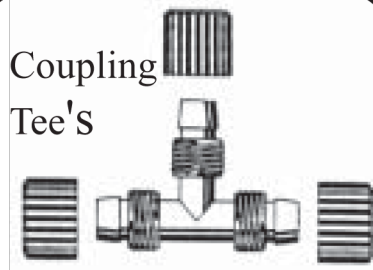

- 500421 3/4p x 1/2p x 1/2p-06824  
 500422 3/4p x 1/2p x 3/4p-06825  
 500427 3/4p x 3/4p x 3/4p-06827  
 500429 3/4p x 3/4p x 1/2p-06826  
 500431 3/8p x 3/8p x 3/8p-06831  
 500432 1/2p x 1/2p x 3/8p-06830  
 500433 1/2p x 1/2p x 1/2p-06820

**Swivel Tee**

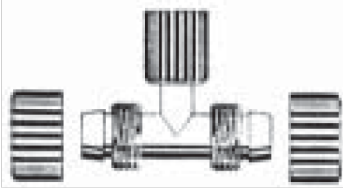

- 500424 1/2p x 1/2p x 1/8fpt-06834  
 500494 1/2p x 1/2p x 1/2fpt-06821  
 500495 1/2p x 1/2p x 3/4fpt-06829

**Pipe Leg Tee**

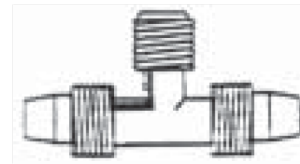

- 500496 1/2p x 1/2p x 1/2mpt-06822

***Flair-It***

**Male Adapter**



- 500434 3/8p x 1/2mpt-06870  
 500435 3/4p x 3/4mpt-06848  
 500437 1/2p x 1/2mpt-06842  
 500439 3/8p x 3/8mpt-06850  
 500452 1/2p x 3/4MGH-06867  
 500457 1/2p x 3/4mpt-06868

**Swivel Elbow**

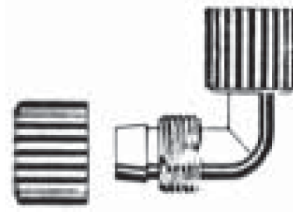

- 500471 1/2p x 1/2fpt-06816  
 500491 3/8p x 1/2fpt-06817  
 500492 1/2p x 3/4fpt-06811  
 500493 3/4p x 3/4fpt-06807

**Rigid Elbow Adapter**

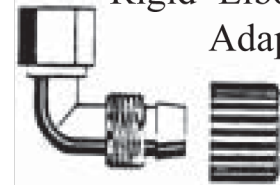

- 500438 3/4p x 3/4fpt-06813

**Elbow Adapter**

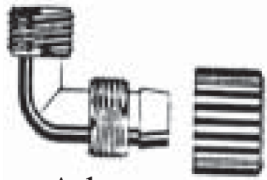

- 500403 1/2px x 1/2mpt-06803  
 500404 3/4px x 3/4mpt-06806  
 500405 3/4px x 1/2mpt-06808  
 500406 1/2px x 3/8mpt-06810  
 500407 1/2px x 3/4mpt-06805

**Coupling**

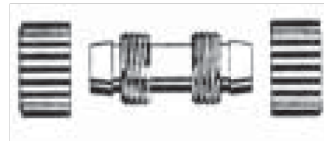

- 500440 1/2p x 1/2p-06840  
 500450 3/4p x 3/4p-06846  
 500451 1/2p x 3/4p-06845  
 500460 3/8p x 3/8p-06855  
 500461 1/2p x 3/8p-06853

**Coupling Elbow**

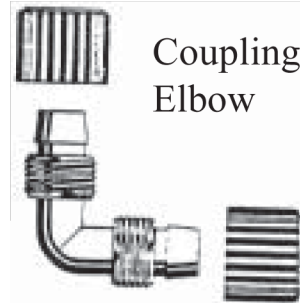

- 500441 1/2p x 1/2p-06800  
 500442 3/4p x 3/4p-06806  
 500462 3/8p x 3/8p-06815  
 500463 1/2p x 3/4p-06805

**Female Adapter**

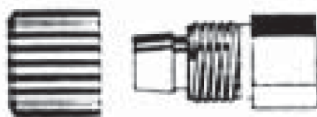

- 500436 1/2p x 1/2fpt-06841  
 500453 3/4p x 3/4fpt-06847  
 500454 1/2p x 3/4fpt-06858  
 500459 1/2p x 3/8fpt-06851

**Copper/Flair-It Transition Fitting**



- 500401 3/8c x 3/8c-02340  
 500501 1/2c x 1/2c-06343  
 500499 3/4p x 3/4c-06349

**Swivel Adapter**

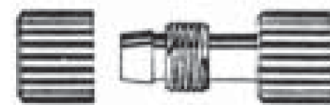

- 500470 1/2p x 1/2fpt-06873  
 500480 3/4p x 3/4fpt-06849  
 500490 3/8p x 1/2fpt-06874  
 500500 1/2p x 3/4fpt-06856

**Bottom Board / Closure Materials**

600249  
14' x 70'  
Mobile-Flex  
Bottom board  
closure

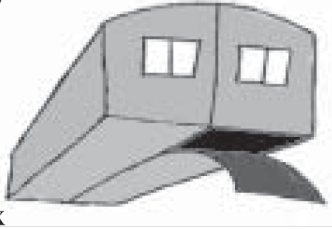

600248  
30" x 100ft. Mobile-Flex  
Bottom board closure -(12 ctn.)



600247  
28" x 25' Flex Mend  
adhesive mending closure-(20 ctn.)



600256 4" x 180'  
Flex-mend tape-(12 ctn)  
600259 2" x 180' Black  
"Super Tape"-(24 ctn)

**Max-BondII  
Construction All  
Purpose Adhesive  
- sticks to every-  
thing!**

600324  
10.6 oz  
24 tubes per ctn.



**6 ml.  
Vapor  
Barrier**

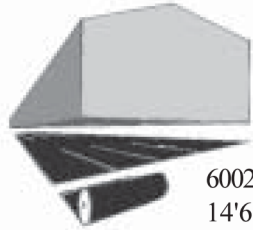

600251  
14'6" x 140ft  
600252  
16' x 150ft



**Sill Seal**

600255  
5 1/2" x 50'  
Poly-Foam Seal

**Accuseal 100**  
Latex Caulk  
600315 White  
600316 Clear  
600317 Almond



**STA'-PUT  
Spray  
Adhesive**

600180  
12 oz. Can  
12 per ctn.



**GEL-GLOSS**

600325  
12 OZ. SPRAY  
-12 per ctn.

600326  
16 OZ.  
LIQUID  
-12 per ctn.

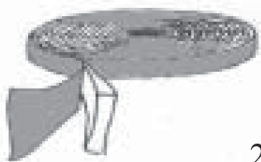

**Putty Tape**  
900080  
20 rls per case

**Mobilehome  
Heating  
Crossovers**



600109 52" long Tie Straps

600110	R-5	10" x 25'
600120	R-5	12" x 25'
600130	R-8	10" x 25' SGC
600140	R-8	12" x 25' SGC
600141	R-5	6" x 20'
600142	R-5	8" x 20'
600145	R-8	14" x 25' SGC

**Duct Connectors,  
Elbows and Tees**

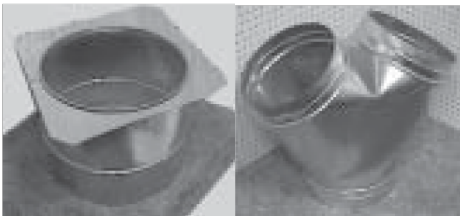

600105 - 12" Wye  
600106 - 12" Tee  
600107 - 10" Elbow  
600108 - 12" Elbow  
600111 - 12" Drop out

**Dryer Duct Outlet**



600143  
4" x 12"

**Adjustable  
Heat  
Registers**



600040 4" x 10" - Brown  
600050 4" x 10" - White  
600060 4" x 8" - Brown  
600070 4" x 8" - White

# Drawer Glide Systems

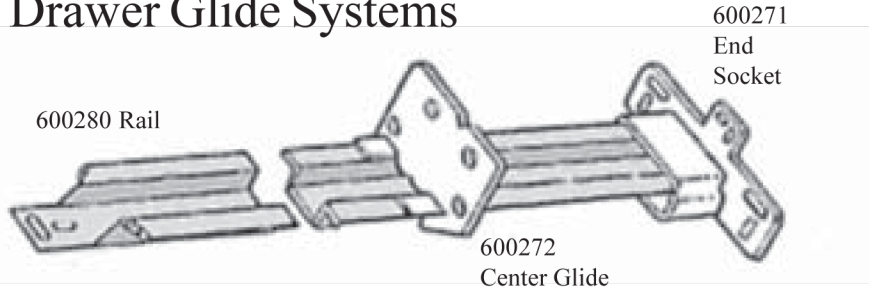

600280 Rail

600271  
End  
Socket

600272  
Center Glide

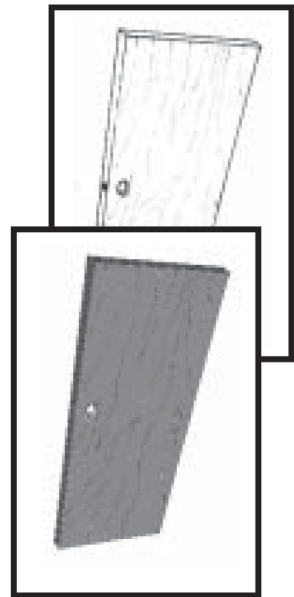

# Closet Door Systems



Sliding  
Closet  
Door  
kit

Replacement  
Hollow-core  
Doors  
-White or Oak  
-Many sizes  
information on  
page 40

600231  
kit includes;  
-two pull  
-one glide  
-four rollers

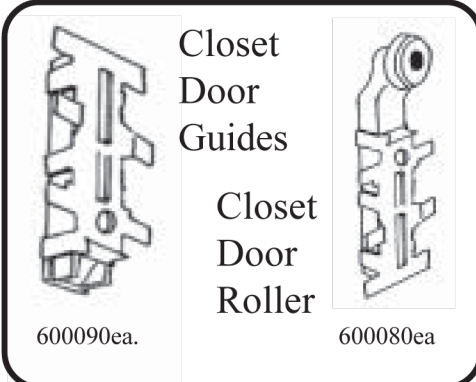

Closet  
Door  
Guides

Closet  
Door  
Roller

600090ea.

600080ea

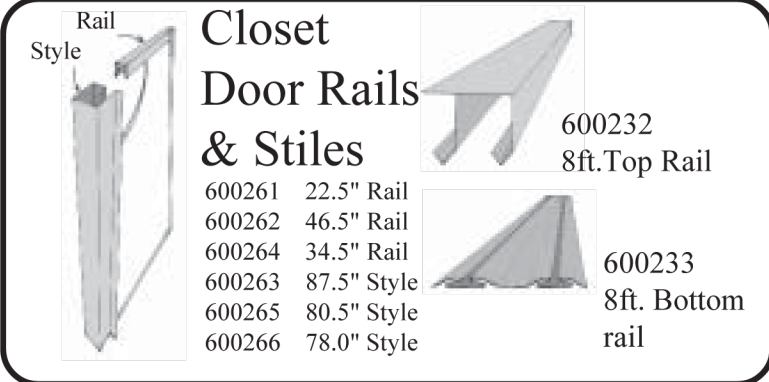

Closet  
Door Rails  
& Stiles

- 600261 22.5" Rail
- 600262 46.5" Rail
- 600264 34.5" Rail
- 600263 87.5" Style
- 600265 80.5" Style
- 600266 78.0" Style

600232  
8ft. Top Rail

600233  
8ft. Bottom  
rail

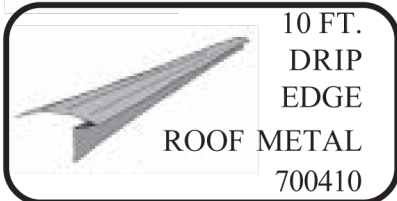

10 FT.  
DRIP  
EDGE  
ROOF METAL  
700410



**890 Roof Coating**  
4 gal per case  
Paint or roll on solvent based white  
elastomeric coating. Coverage is  
approximately 300 square ft. per  
gallon  
Can be installed in temp. to freezing  
and displaces water

700500 700510  
5 gal 1 gal-4/cs.

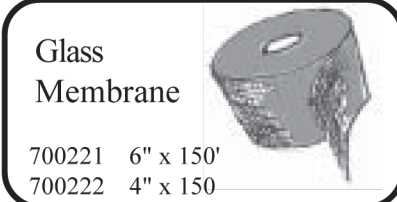

Glass  
Membrane  
700221 6" x 150'  
700222 4" x 150'



**C-10 Flo Seal**  
Self-leveling caulking for  
sealing vents. Available in  
white or grey-11 oz tubes  
700530 700531  
White Grey

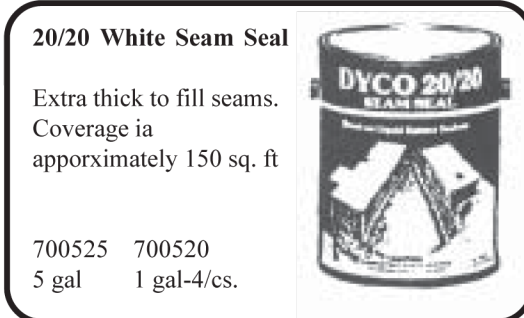

**20/20 White Seam Seal**  
Extra thick to fill seams.  
Coverage is  
approximately 150 sq. ft  
700525 700520  
5 gal 1 gal-4/cs.

# Electrical Parts



**Deco Switches**

- |        |            |
|--------|------------|
| 800403 | 800433     |
| Brown  | Brn-3-way  |
| 800404 | 800434     |
| Ivory  | Ivry-3-way |
| 800405 | 800435     |
| White  | Wht-3-way  |

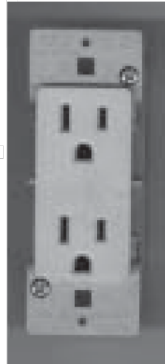

**Deco Receptacle**

- 800406  
Brown  
800407  
Ivory  
800408  
White

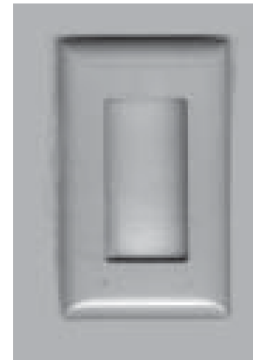

**Deco Single Plate**

- 800396  
Brown  
800397  
Ivory  
800398  
White



**Triple Plate**

- 800426  
Ivory  
800427  
White

**Replacement Wing Nuts & Screws**



800423 Wing Nut  
800424 Ivory Screw  
800425 White Screw

**Deco Dble. Plate**

- 800420  
Ivory  
800421  
White

**Dryer Cord**

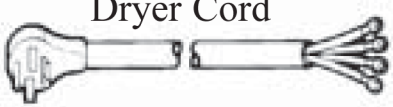

800010



NEMA 14-30P  
30A-125/250V

**Range Cord**



800011



NEMA 14-50P  
50A-125/250V

**HUD Dryer Receptacle**

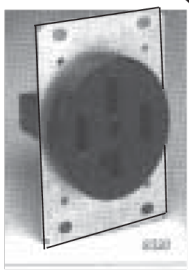

800020

**HUD Range Receptacle**

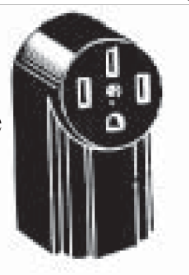

800021

**Ground Fault Interrupter**



800416  
White  
800417  
Ivory

**Electric Furnace Thermostats**



800110  
Std. T-Stat

**Smoke Detector**



**FIREX**

800100 110v  
800101 w/ 9v bat. back up

**Intermatic #E1020 Bath Fan Timer**



800310

# Lighting & Globes

## Vanity Lighting



800062 4-bulb base  
800063 Lens only

800068 2-Bulb base  
800069 Lens only

## Globe Lights



800050 Base only  
800051 Base w/switch



800070  
6" White  
w 3 1/4" opening



800073  
6" Crystal Globe  
w 3 1/4" opening



800058 "Jelly Jar"  
acrylic  
800059 "Jelly Jar"  
glass



800130 White Plastic  
base only

## 4" Base w/ 5" Drop

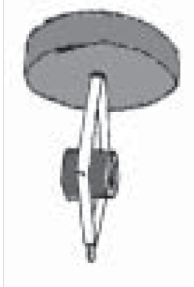

800055 Base

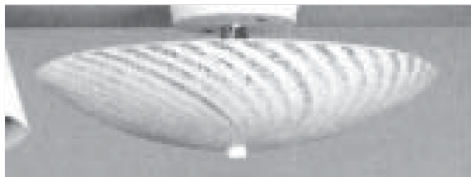

800030 13" Glass Shade only

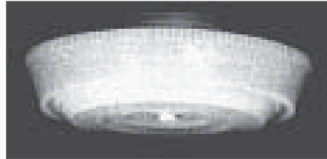

800040  
12" Plastic  
Shade only

## Ceiling Lighting

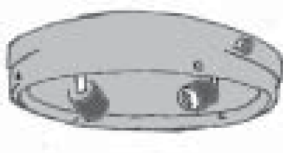

800054 6" Base-sgl. bulb  
800053 8" Base-dble bulb



800049 6"  
800048 8"



800064 6"  
800065 8"

## Replacement Finnial Nuts



800120

## VentlinePower vent w/light

-7 1/2" vent size  
-11" recess  
-100cfm



800168 assy.  
800169 lens only

## Candelabra Wall Base

800088  
w/Switch  
800089  
w/o Switch  
800072  
Grapevine  
chimney  
w/2"

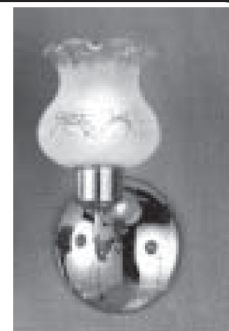



700401-5" DIA.  
700402-7" DIA



700399 14" x 14" White Vent

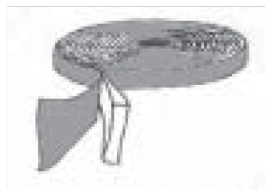

900080 Putty Tape  
-20 rolls per case

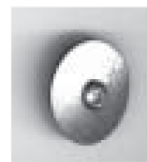

700600  
Rumble Buttons  
100 pk



500510-2 1/2" DIA.  
700400-5" DIA.  
700403-7" DIA.

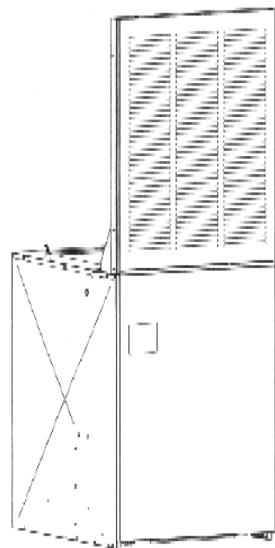

## MORTEX Electric Furnaces

800205*	10KW-240V-34,000BTU
800206*	12KW-240V-39,000BTU
800207*	15KW-240V-51,000BTU
800208*	17KW-240V-55,000BTU
800209*	20KW-240V-67,000BTU

These Furnaces are 19" wide x 23 1/2" deep  
and 30" tall. Prices include the floor plenum.  
*-Return-air grill not included*

## H.U.D. APPROVED 240v. Electric & Gas Water Heaters

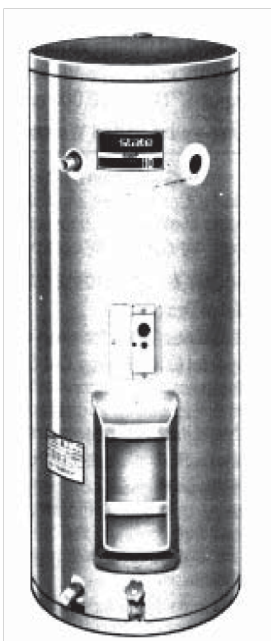

### ELECTRIC

- 800143 30 gallon 2 ele.-side tap-4500watt 18" x 39 1/4" 101 lbs
- 800144 40 gallon 2 ele.-side tap-4500watt 18" x 50 1/4" 120 lbs.
- 800147 50 gallon 2 ele.-side tap-5500watt 18" x 50 1/4" 151 lbs.
- 800148 50 gallon 2 ele.-top tap-5500watt 18" x 50 1/2" 151lbs

-all water heaters are 88 percent Energy Rating  
-3/4 Pop-off not included

### GAS Water Heaters

- 800145\* 40 gal. gas 17 3/4" x 51 1/2"
- 800146\* 50 gal. gas 17 3/4" x 51 1/2"
- 800141\* Vent

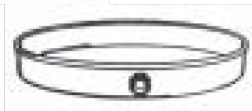

800142  
20" Drip Pan



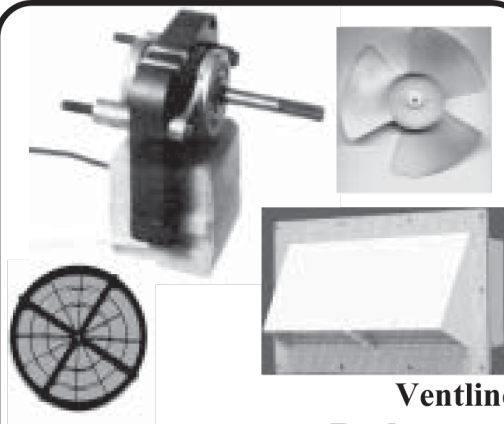

**BROAN  
Replacement  
Parts**

- 800189B\* Broan vent motor
- 800193B\* Rep. light lens
- 800192B\* Rep. filter 8 7/16 x 11 1/4
- 800195B\* Rep. fan blade
- 800199B\* 5" Duct conector with damper

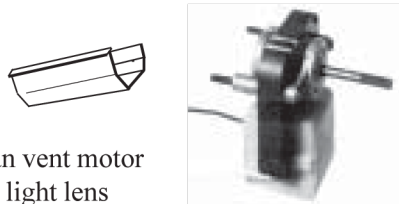

**Ventline  
Replacement  
Parts**

- 800160 Motor-fits 800168 & 800170
- 800160N Nuts for motor
- 800162 Rep. 5- blade for 800161, 800168, 800170
- 800189 Motor-fits all Ventline range vents
- 800190 fits 700450 & 800161
- 800192 Rep. Filter- 8" x 8"
- 800193 Rep. Light Lens- 9" x 3 1/2"
- 800194 Rep. Rotary Switch
- 800195 Rep. 5-blade-Ventline range vents
- 800188 Rep Horiz. Vent-3 1/2 x 10 1/4"

**9 1/2"  
SIDE  
WALL FAN**

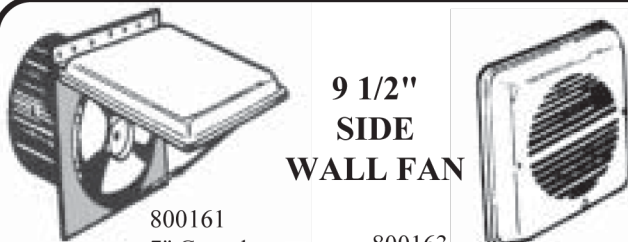

800161  
7" Complete  
Assy.

800163  
Chrome Int.  
Grill

**7 1/2"  
BATH FAN  
ASSY.**



800170-Complete  
800169-Cover  
-old or new  
800167-Damper



**ATTIC  
VENT**  
700450

**7 1/2" BATH ROOM  
FAN W/LIGHT**



800168 Complete  
800165 Lens only  
800167-Damper only

**Range Vents**



- 800174B 30" Alm. w/Lt. & 5" vert. vent
- 800175B 30" White w/Lt. & 5" vert. vent
- 800176B 42" Alm. w/Lt. & 5" vert vent
- 800177B 42" Wh. w/Lt. & 5" vert
- 800178B 30" Alm w/Lt. & horiz. vent
- 800179B 30" White with Light & horiz. vent
- 800180B 42" Almond with Light & horiz. vent
- 800181B 42" White with Light & horiz. vent
- 800186B 30" Alm. w/Lt.-Ventless
- 800187B 30" White w/Lt.-Ventless

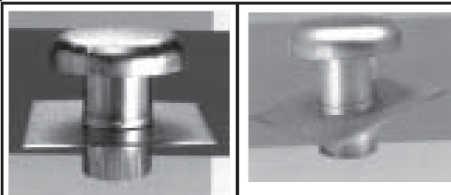

700400 5" flat      700401 5" sloped

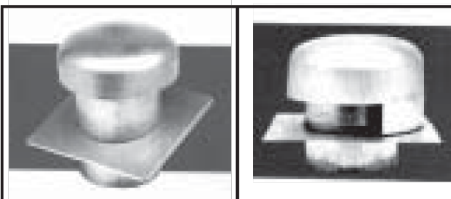

700402 7" sloped      700403 7" flat



**1/3 h.p.  
Sink  
Disposal**

800151\*



# Door Hardware

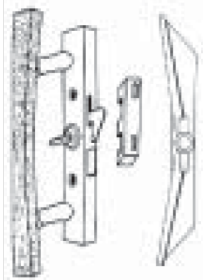

## Sliding Glass Door Locks

900262- fits Philips Vinyl frame S.G.D.  
900263- Lock cylinder to fit 900262



## Door Strike Plate

900273  
2 1/2 O.A.  
length



900274  
Brass



## Lever-handle

### Door lock

2 3/8" backset-7/8" bolt  
900033 Privacy  
900032 Passage



## Exterior 1" Drive-in Doorlocks & Deadbo

900009 Dead Bolt-adj.b.s.  
900010 Dead bolt-2 3/4 b.s.  
900013 Door Lock only-adj. b  
900013L Door Lock only-adj. b  
900014 Door Lock only 2 3/4 b.s.  
900025 Combo Lock & D.B-adj. b.s.  
900027 Combo Lock & D.B.-2 3/4 b.s.

900070  
Brass Floor mt.



## Interior Door Lock

2 3/8 backset-7/8" bolt  
900030 Standard Passage  
900040 Standard Privacy

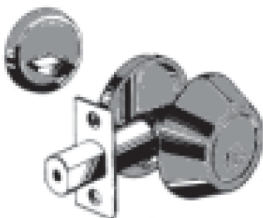

## Custom Replacement Sliding Glass Door Screen



907888\* - Specify exact size & mill, white or bronze finish

## Replacement Latchbolts



## Exterior

900036 - 5" Plate-style for Kwikset  
900038- 2 3/4 1" Drive-in for Kwikset  
900041 - Adj.-2 3/8-2 3/4" for 900013  
900044 - Adj.-2 3/8-2 3/4" for 90009  
900048 - Plate-style Converter plate



900048



900042

## Interior

900042 - Plastic - 2 3/8 backset for 7/8" O.D.- "D" bolt  
900042B- Metal - 2 3/8 backset for 7/8" O.D.





### Non-Mortised Door Hinges

900050 1pr.

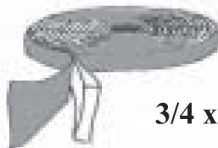

### Putty Tape

3/4 x 1/8" x 30 ft. rolls  
900080-Gray Putty  
(20 rls. per case)

900255 OREPAC SEAL  
-1PC-7FT.

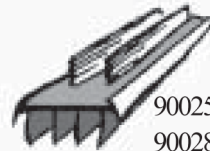

900253 32"  
900287 36"

### Door Sweeps & Seals

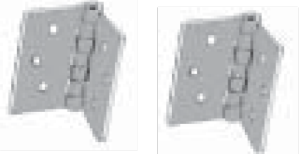

### Mortised Brass-plated Door Hinges

900051 pr.

### Storm & Screen Door Spring Set



900045



### Screen & Storm Door Closer Kit

900289

### DOOR VIEWER



-All Brass Construction  
-1 3/8" - 2 1/4" Thickness  
-9/16 hole size  
900271

### Door Windows

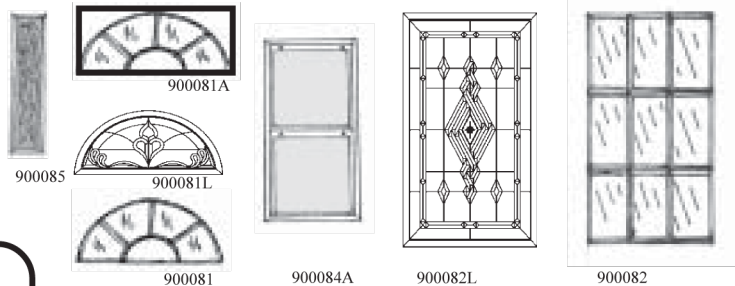

900081A  
900085  
900081L  
900081  
900084A  
900082L  
900082

900081\* -SUNBURST radius  
900081L\* -SUNBURST *Leaded* radius insg.  
900081A\*-SUNBURST squared  
900082\* -9-LITE for insg -22 1/2" x 36 1/2"  
900082L\*-1/2-LITE-*Leaded* insg-22 1/2" x 36 1/2"  
900083P\*-COTTAGE for Philips-20 1/2" x 36 1/2"  
900084A\*-SLDR. for Philips-14 3/4" x 30"-obscure  
900084ACL\*-SLDR. for Philips-14 3/4" x 30"-clear  
900085\* -SLOT for Elixer-5" x 25"-obscure  
900085P-SLOT for Philips-5" x 25"-obscure

## Doors

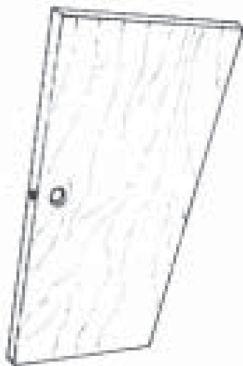

### "Embossed White"

900095 24" x 80"  
900096 26" x 80"  
900097 28" x 80"  
900098 30" x 80"

### "Oak"

900087\* 18" x 80"  
900088\* 20" x 80"  
900090 24" x 80"  
900091 26" x 80"  
900092 28" x 80"  
900093 30" x 80"  
900094\* 36" x 80"

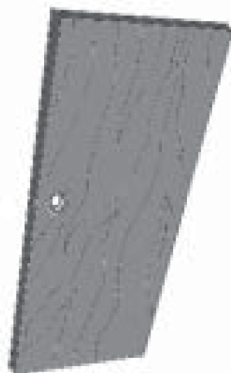

**808888\***  
Custom water heater access doors  
-Call for options

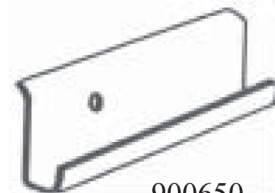
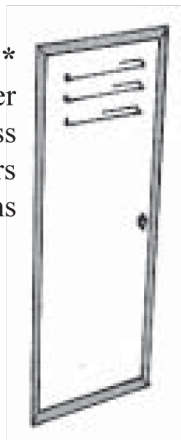

900650  
1 1/8 X 16  
DRIP RAIL

# In-Swing Entry Doors

Featuring:

- the highest insulation features available
- Separate interior and exterior steel jacketing.
- Thermo-pane windows
- Primered 4" wood jambs standard and 6" available on Special Order



*-6" Jams are available as a Special Order item.*

**Order under**

- 978888-BL**
- 978888-9L**
- 978888-SB**
- 978888-15L**

Our determination for "door swing" is made by standing on the outside of the home and looking at which side the door's hinges are located.

## Embossed 6-PANEL

### In-Swing Doors

973074R-BL	6-panel 30" x 74"RH
973074L-BL	6-panel 30" x 74"LH
973274R-BL	6-Panel 32" x 74"RH
973274L-BL	6-Panel 32" x 74"LH
973276R-BL	6-Panel 32" x 76"RH
973276L-BL	6-Panel 32" x 76"LH
973278R-BL	6-Panel 32" x 78"RH
973278L-BL	6-Panel 32" x 78"LH
973678R-BL*	6-Panel 36" x 78"RH
973678L-BL*	6-Panel 36" x 78"LH
973680R-BL*	6-Panel 36" x 80"RH
973680L-BL*	6-Panel 36" x 80"LH

### Embossed In-Swing Door

#### with a 9-LITE Window

973274R-9L*	9-LITE 32" x 74"RH
973274L-9L*	9-LITE 32" x 74"LH
973276R-9L*	9-LITE 32" x 76"RH
973276L-9L*	9-LITE 32" x 76"LH
973278R-9L*	9-LITE 32" x 78"RH
973278L-9L*	9-LITE 32" x 78"LH
973678R-9L*	9-LITE 36" x 78"RH
973678L-9L*	9-LITE 36" x 78"LH

### Embossed In-Swing Door

#### with a SUNBURST Window

973074R-SUN	SUNBURST 30" x 74"RH
973074L-SUN	SUNBURST 30" x 74"LH
973274R-SUN	SUNBURST 32" x 74"RH
973274L-SUN	SUNBURST 32" x 74"LH
973276R-SUN	SUNBURST 32" x 76"RH
973276L-SUN	SUNBURST 32" x 76"LH
973278R-SUN	SUNBURST 32" x 78"RH
973278L-SUN	SUNBURST 32" x 78"LH
973678R-SUN*	SUNBURST 36" x 78"RH
973678L-SUN*	SUNBURST 36" x 78"LH

### Embossed In-Swing Door

#### with a 15-LITE Window

973274R-15L*	15-LITE 32" x 74"RH
973274L-15L*	15-LITE 32" x 74"LH
973276R-15L*	15-LITE 32" x 76"RH
973276L-15L*	15-LITE 32" x 76"LH
973278R-15L*	15-LITE 32" x 78"RH
973278L-15L*	15-LITE 32" x 78"LH
973678R-15L*	15-LITE 36" x 78"RH
973678L-15L*	15-LITE 36" x 78"LH

# Outswing Doors

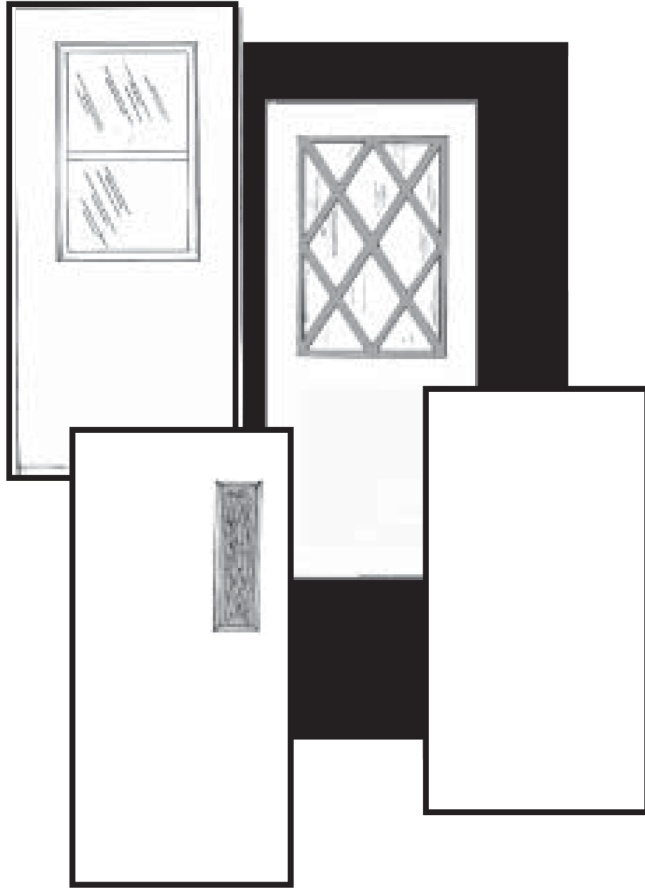

All doors are supplied with a primed Whitehard-board cedar embossed finish.

Special order options include:

- R.H. Swing
- Dead bolt
- R.V. Style screen

963072P-BL	30" x 72" LH Blank
963072P-SD	30" x 72" LH Slider
963074P-BL	30" x 74" LH Blank
963074P-SD	30" x 74" LH Slider
963076P-BL	30" x 76" LH Blank
963076P-SD	30" x 76" LH Slider
963076P-ST	30" x 76" LH Slot
963076PR-SD*	30" x 76" RH Slider
963078P-BL*	30" x 78" LH Blank
963078P-SD*	30" x 78" LH Slider
963080P-BL*	30" x 80" L.H. Blank
963272P-BL	32" x 72" LH Blank
963272P-SD	32" x 72" LH Slider
963274P-BL	32" x 74" LH Blank
963274P-SD	32" x 74" LH Slider
963276P-BL	32" x 76" LH Blank
963276P-SD	32" x 76" LH Slider
963276PR-SD*	32" x 76" R.H. Slider
963276P-ST	32" x 76" LH Slot
963276P-CT	32" x 76" LH Cottage
963276PR-CT*	32" x 76" R.H. Cottage
963276P-RV*	32" x 76" LH Slot w/Screen
963278P-BL	32" x 78" LH Blank
963280P-BL*	32" x 80" L.H. Blank
963476P-BL*	34" x 76" LH Blank
963680P-BL	36" x 80" LH Blank



The call out sizes are the actual dimensions of the 'rough-out' hole in the wall. Determination of door swing is made by standing on the outside of the home and finding what side the hinges are located on. All outswing doors are pre-hung.

## Special Order Door Policy

Any single-item special order door will be supplied as a Philips brand door. All special order-door sales are final.

# Energy Efficient

## Sliding Glass Doors

- Thermal-pane doors
- P.V.C. all-fused vinyl framing
- Optional Argon
- Reversible window panes

927276-OX	71.5" x 76.5"
927276-XO	71.5" x 76.5"
927276-SP*	71.5" x 76.5" w/argon
927280*	71.5" x 79.5"
927280-SP*	71.5" x 79.5" w/argon

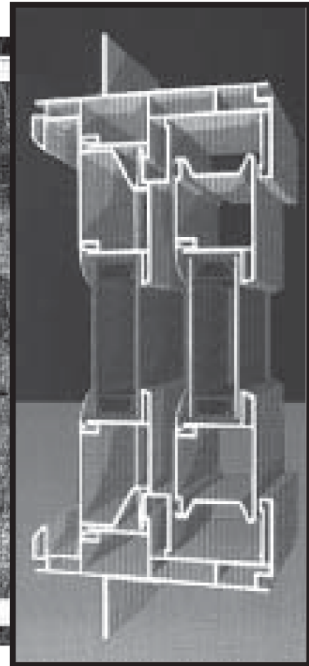
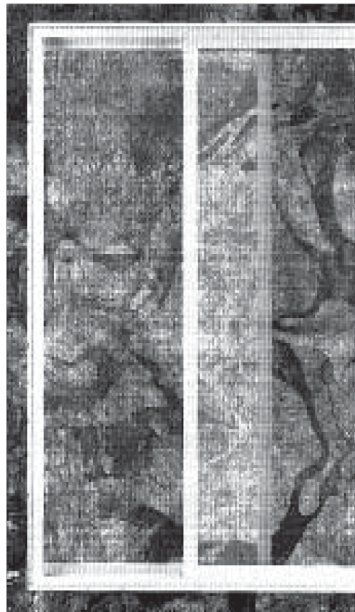

## LEXAN SKYLIGHTS O.E.M. Sizes

- 900800 -14x46 Curb mount
- 900801 -14x46 Flush mount
- 900803\* -14x30 Curb mount
- 900804\* -14x30 Flush mount
- 900805 -30x46 Curb mount
- 900809 -30x46 Flush mount
- 900807\* -22x46 Curb mount
- 900802\* -22x46 Flush mount
- 900814\* -22x22 Curb mount
- 900808\* -22x22 Flush mount
- 900806\* -46x46 Curb mount
- 900813\* -46x46 Flush mount



## All Glass Skylights w/Anodized frame

- bronze-TIG welded frames
- PVC Thermobreak inner frames
- Insulated low-profile dome
- Water-tight seals using PVC glazing
- This product available as a special order option only



## Storm Doors

made to fit our **IN-SWING** Doors

All doors have white enameled finish framing with a slide up window for additional circulation.

Framed with T-6 structural aluminum.

983274L	Philips Recess Mt.-31 1/4" x 73 3/8"blank size
983274R	Philips Recess Mt.-31 1/4" x 73 3/8"blank size
983276L	Philips Recess Mt.-31 1/4" x 75 3/8"blank size
983276R	Philips Recess Mt.-31 1/4" x 75 3/8"blank size
983278L	Philips Recess Mt.-31 1/4" x 77 3/8"blank size
983278R	Philips Recess Mt.-31 1/4" x 77 3/8"blank size
983280L	Philips Recess Mt. 31 1/4" x 79 3/8"blank size
983280R	Philips Recess Mt. 31 1/4" x 79 3/8"blank size
983680L	Philips Recess Mt.-35 1/4" x 79 3/8"blank size
983680R	Philips Recess Mt.-35 1/4" x 79 3/8"blank size

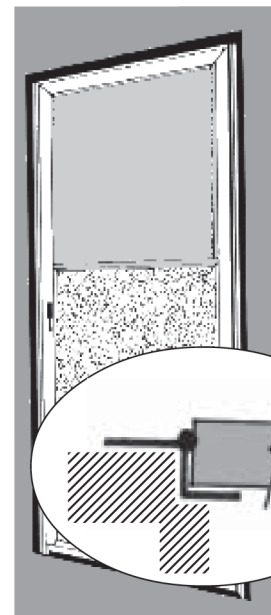

RECESS MOUNT for  
BRICKMOLD STYLE FRAME

# Philips Vinyl Windows

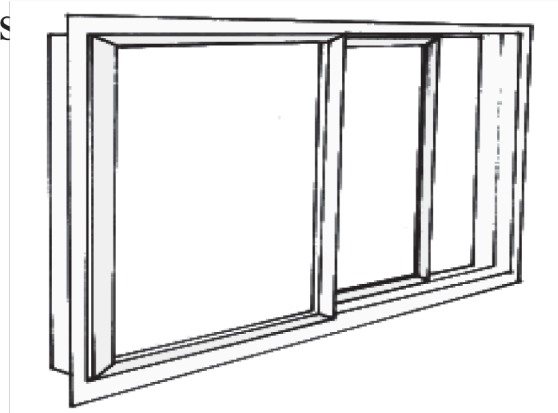
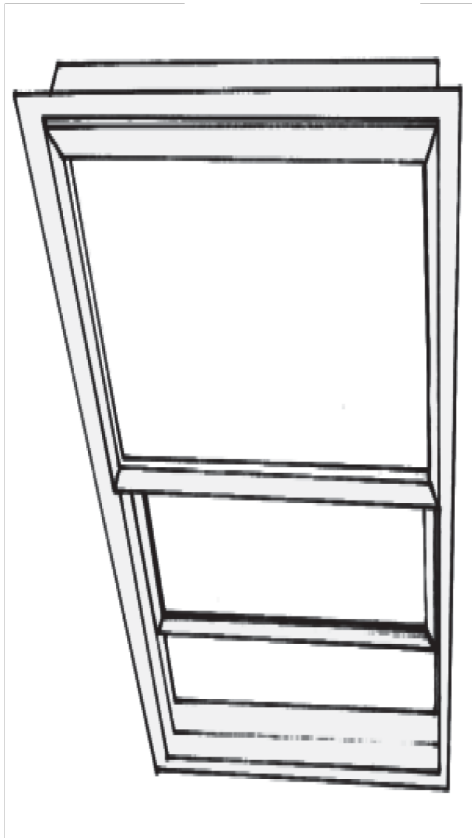

Actual Call-out Sizes WIDTH X HEIGHT	VINYL WINDOW STYLE		
	Horizontal Part #	XOX Part #	Single Hung Part #
14.25 X 27.062			921428V
14.25 X 39.625			921439V
14.25 X 42			921442V
36.25 X 7.5	923608H		
30.25 X 27.062	923027H		923027V
30.25 X 39.625	923039H		923039V
30.25 X 53.312			923053V
30.25 X 58.625			923058V
46.25 X 27.062	*		
46.25 X 39.625 #	924639H		924639V
46.25 X 52.312 #	924652H		
62.25 X 27.062	*		
62.25 X 39.625 #	926239H		
62.25 X 52.312 #	926252H		
78.25 X 39.625		*	
78.25 x 52.312		927852H	

## Special Order Options

- Low E
- Argon Gas filled
- Obscure Glass
- Tan color vinyl

**-ALL OUTLINED BOXES  
INDICATE STOCKED  
INVENTORY.**

# MEETS HUD EGRESS STANDARDS

ALL WINDOWS REQUIRING TAN, LOW  
E, ARGON, AND/OR GRIDS ARE TO BE  
SPECIAL ORDERED UNDER  
PART # 9288888-SPECIFY SIZE